

## Preparation of Copper Ion Complexes of Sterically Congested Diaryldiazomethanes Having a Pyridine Ligand and Characterization of Their Photoproducts

Tetsuji Itoh, Masayoshi Matsuno, Eiko Kamiya, Katsuyuki Hirai, and Hideo Tomioka

*J. Am. Chem. Soc.*, 2005, 127 (19), 7078-7093 • DOI: 10.1021/ja0424225 • Publication Date (Web): 22 April 2005

Downloaded from <http://pubs.acs.org> on March 25, 2009

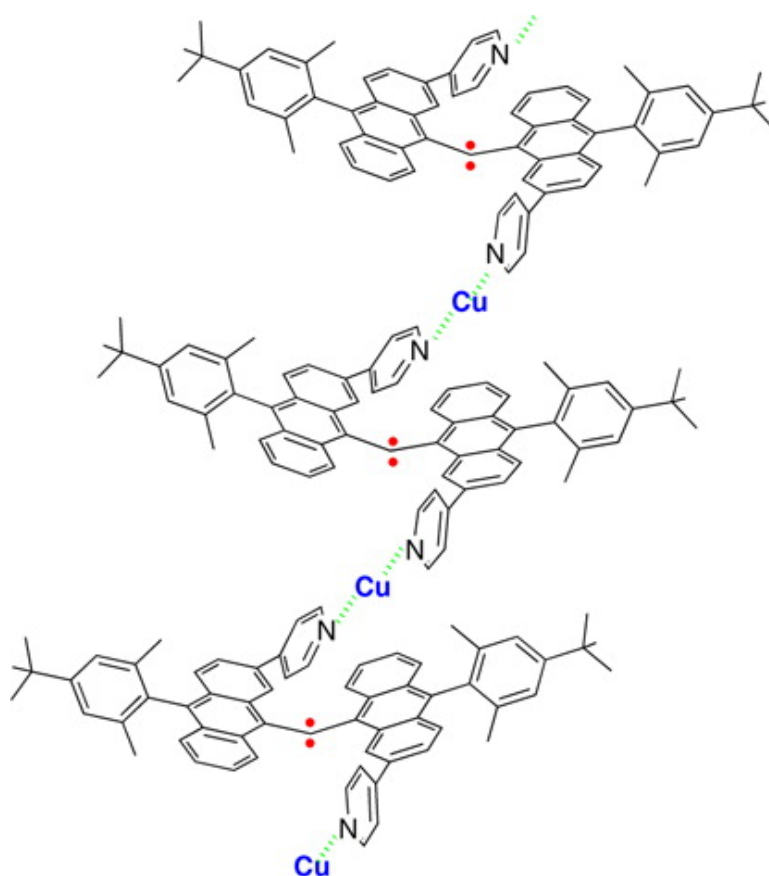

### More About This Article

Additional resources and features associated with this article are available within the HTML version:

- Supporting Information



**ACS Publications**  
 High quality. High impact.

- Links to the 1 articles that cite this article, as of the time of this article download
- Access to high resolution figures
- Links to articles and content related to this article
- Copyright permission to reproduce figures and/or text from this article

[View the Full Text HTML](#)



## Preparation of Copper Ion Complexes of Sterically Congested Diaryldiazomethanes Having a Pyridine Ligand and Characterization of Their Photoproducts

Tetsuji Itoh,<sup>†</sup> Masayoshi Matsuno,<sup>†</sup> Eiko Kamiya,<sup>†</sup> Katsuyuki Hirai,<sup>‡</sup> and Hideo Tomioka<sup>\*†</sup>

*Contribution from the Chemistry Department for Materials, Faculty of Engineering, and Instrumental Analysis Facilities, Life Science Research Center, Mie University, Tsu, Mie 514-8507, Japan*

Received December 16, 2004; E-mail: tomioka@chem.mie-u.ac.jp

**Abstract:** To realize fairly stable high-spin polycarbenes by utilizing heterospin systems comprising 2p spins of organic radicals and 3d spins of magnetic metal ions, we prepared dianthryldiazomethanes having two pyridyl groups at the 2,2'- or 2,7-positions, that is, bis[10-(4-*tert*-butyl-2,6-dimethylphenyl)-2-(4-pyridyl)-9-anthryl]diazomethane (2,2'-DPy-1-N<sub>2</sub>) and [10-(4-*tert*-butyl-2,6-dimethylphenyl)-9-anthryl]([10-(4-*tert*-butyl-2,6-dimethylphenyl)-2,7-di(4-pyridyl)-9-anthryl]diazomethane (2,7-DPy-1-N<sub>2</sub>). The triplet carbene DPy-<sup>3</sup>1 generated by photolysis of DPy-1-N<sub>2</sub> was characterized by ESR and UV-vis spectroscopy in a matrix at low temperature as well as by time-resolved UV-vis in solution at room temperature. The results showed that the triplet carbene DPy-<sup>3</sup>1 was destabilized to some extent as opposed to the parent triplet carbene before pyridination, but it was still fairly persistent, having a half-life of more than 30 min in solution at room temperature. Photoproducts from the complex between DPy-1-N<sub>2</sub> and Cu(hfac)<sub>2</sub> were characterized in a similar manner, and the results suggested that the generated carbene centers interacted magnetically with the Cu(II) ion to form a high-spin species with significant thermal stability. The fact that no significant signals due to the isolated triplet carbene DPy-<sup>3</sup>1 were observed suggested that the pyridine moiety binds with Cu(hfac)<sub>2</sub> in a nearly quantitative manner under these cryogenic conditions. Magnetic measurements of the photoproduct using a superconducting quantum interference device (SQUID) magneto/susceptometer were performed to determine the spin state of the complex. The temperature dependence of the molar paramagnetic susceptibility indicated the presence of ferromagnetic interaction. The field dependences of magnetization for the complexes, expressed using *M* versus *H/T* plots, were analyzed in terms of the two-component Brillouin function to be *S* = 3.18 (*F* = 0.66) and *S* = 0.02 (*F* = 0.23) for the 1:1 complex of 2,7-DPy-1 and Cu(hfac)<sub>2</sub> and *S* = 2.70 (*F* = 0.33) and *S* = 0.49 (*F* = 0.11) for the 1:1 complex of 2,2'-DPy-1 and Cu(hfac)<sub>2</sub>.

### Introduction

An ever-increasing amount of interest is being paid to molecular magnetism, in which spins of unpaired electrons in  $\pi$ -orbitals of light atoms such as carbon, nitrogen, and oxygen are mainly responsible for the magnetic properties. Many attempts have been made to prepare organic ferromagnetic materials.<sup>1,2</sup> The spin sources used for such studies are mostly thermodynamically stable radicals such as phenoxyls,<sup>3</sup> triphenylmethyls,<sup>4</sup> and nitroxides,<sup>5</sup> mostly because of their ease of preparation and use. Triplet carbenes seem to be more attractive spin sources in that their spin density is twice as large as that of radicals, and hence the magnitude of the exchange coupling between neighboring centers is large.<sup>6,7</sup> Iwamura and

co-workers have prepared a "starburst"-type nonadiazido compound, a precursor of nonacarbene, and have demonstrated that the nine diazo groups are photolyzed at low temperature to give a nonadecet ground state (*S* = 9).<sup>7</sup>

However, these systems have two disadvantages that hinder their extension to usable magnetic materials. First, a triplet carbene unit is highly unstable and lacks stability for practical

<sup>†</sup> Chemistry Department for Materials.

<sup>‡</sup> Instrumental Analysis Facilities.

(1) (a) Iwamura, H. *Adv. Phys. Org. Chem.* **1990**, *26*, 179. (b) Dougherty, D. A. *Acc. Chem. Res.* **1991**, *24*, 88. (c) Rajca, A. *Chem. Rev.* **1994**, *94*, 871. (d) *Molecular Magnetism in Organic-Based Materials*; Lahti, P. M., Ed.; Marcel Dekker: New York, 1999. (e) Itoh, K., Kinoshita, M., Eds.; *Molecular Magnetism*; Kodansha-Gordon and Breach: Tokyo, 2000.

(2) (a) Kahn, O. *Molecular Magnetism*; VCH Publishers: Weinheim, Germany, 1993. (b) Gatteschi, D. *Adv. Mater.* **1994**, *6*, 635. (c) Miller, J. S.; Epstein, A. J. *Angew. Chem., Int. Ed. Engl.* **1994**, *33*, 385. (d) Miller, J. S.; Epstein, A. J. *Chem. Eng. News* **1995**, (Oct 2), 30. (e) *Magnetism: A Supramolecular Function*; Kahn, O., Ed.; NATO ASI Series C; Kluwer: Dordrecht, The Netherlands, 1996; Vol. 484. (f) *Molecule-Based Magnetic Materials*; Turnbull, M. M., Sugimoto, T., Thompson, L. K., Eds.; ACS Symposium Series 644; American Chemical Society: Washington, DC, 1996. (g) Gatteschi, D. *Curr. Opin. Solid State Mater. Sci.* **1996**, *1*, 192. (h) Miller, J. S.; Epstein, A. J. *MRS Bull.* **2000**, *25*, 21. (i) *Magnetism: Molecules to Materials II*; Miller, J. S., Drillon, M., Eds.; Wiley-VCH: Weinheim, Germany, 2001. (3) (a) Nishide, H.; Kaneko, T. In *Molecular Magnetism in Organic-Based Materials*; Lahti, P. M., Ed.; Marcel Dekker: New York, 1999; pp 285–303. (b) Nishide, H.; Maeda, K.; Oyaizu, K.; Tsuchida, E. *J. Org. Chem.* **1999**, *64*, 7129. (c) Nishide, H.; Takahashi, M.; Takashima, J.; Tsuchida, E. *J. Org. Chem.* **1999**, *64*, 7129.

applications under ambient conditions.<sup>8</sup> To overcome these difficulties, we have made great efforts to stabilize them,<sup>9,10</sup> and we succeeded in preparing fairly stable ones that survive for several days in solution at room temperature.<sup>10e</sup> The next step is to explore a way of connecting them while retaining a robust  $\pi$ -spin polarization.

The second disadvantage is that diazo groups, which are generally employed as precursors of carbenes, are also, in general, labile<sup>11</sup> and hence cannot be used as building blocks to prepare more complicated poly(diazo) compounds. We found that a diphenyldiazomethane prepared to generate a persistent triplet carbene is also persistent for the diazo compound. Hence, this can be further modified into a more complicated diazo compound, with the diazo group intact. For instance, (2,4,6-tribromophenyl)(2,6-dibromo-4-*tert*-butylphenyl)diazomethane was found to be stable enough to survive under Sonogashira coupling reaction conditions and undergoes a coupling reaction with (trimethylsilyl)acetylene to give (2,6-dibromo-4-trimethylsilylethynylphenyl)(2,6-dibromo-4-*tert*-butylphenyl)diazomethane. Three units of the diazo compound are then introduced at the 1-, 3-, and 5-positions of the benzene ring through the ethynyl group by employing a similar coupling reaction to give a tris(diazo) compound, which eventually generates a fairly stable septet ground-state tris(carbene) upon irradiation.<sup>12</sup> Thus it is potentially possible to prepare a poly(diazo) compound by extending this method.<sup>13</sup>

Scheme 1

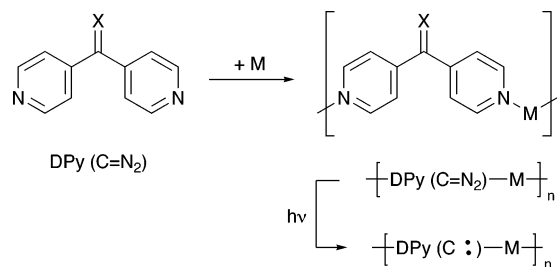

However, there are still other problems that prevent the formation of high-spin systems. Thus, efforts to increase the number of aligned spins are sometimes hampered by the development of antiferromagnetic intra- and/or interchain interactions between the radical centers.<sup>7d</sup>

To overcome these problems, heterospin systems comprising 2p spins of organic radicals and 3d spins of magnetic metal ions have been proposed.<sup>6,14</sup> The strategy is based on the supramolecular chemistry exhibited by pyridine- and polypyridine-metal ions.<sup>15</sup> For instance, magnetic interaction between radical centers and metal ions can be realized through a pyridyl ligand to generate a high-spin unit. Thus, bis(4-pyridyl)diazomethane [DPy-(C=N<sub>2</sub>)] forms a polymeric chain structure by ligation with coordinatively unsaturated metal ions (M). The 3d spins on the metal ions in the chain [-DPy-(C=N<sub>2</sub>)-M-]<sub>n</sub> do not interact with each other, but once triplet bis(4-pyridyl)carbene is generated upon irradiation to form the carbene-metal ion complex [-DPy-(C:)-M-]<sub>n</sub>, they start to interact with each other through the 2p spins on the carbene center, thereby generating a high-spin system comprising 2p and 3d spins (Scheme 1).<sup>6,14</sup>

This suggests that if a pyridyl group is introduced onto an aryl ring of a sterically congested diaryldiazomethane, a precursor for a persistent triplet carbene, a polymeric diazo compound should be obtained after coordination with metal ions. From this, a persistent high-spin molecule comprising 2p spins of organic radicals and 3d spins of magnetic metal ions will be formed.

We report here that dianthryldiazomethanes bearing two pyridine groups form complexes with Cu(II) that, upon irradiation, generate fairly stable high-spin species.

## Results and Discussion

### Design and Preparation of Desired Diaryldiazomethane Bearing a Pyridyl Group. We chose bis[10-(2,6-dimethyl-4-

- (4) (a) Raica, A. In *Molecular Magnetism in Organic-Based Materials*; Lahti, P. M., Ed.; Marcel Dekker: New York, 1999; pp 345–359. (b) Raica, A. *Chem.-Eur. J.* **2002**, *8*, 4835. (c) Raica, A.; Wongsriatanakul, J.; Raica, S. *J. Am. Chem. Soc.* **2004**, *126*, 6608. (d) Raica, A.; Wongsriatanakul, J.; Raica, S.; Cerny, R. L. *Chem.-Eur. J.* **2004**, *10*, 3144.
- (5) Bushby, R.-J. In *Magnetism: Molecules to Materials II*; Miller, J. S., Drillon, M., Eds.; Wiley-VCH: Weinheim, Germany, 2001; pp 149–187. (b) Amabilino, D. B.; Viciano, J. In *Magnetism: Molecules to Materials II*; Miller, J. S., Drillon, M., Eds.; Wiley-VCH: Weinheim, Germany, 2001; pp 1–60. (c) Ishimaru, Y.; Kitano, M.; Kumada, H.; Koga, N.; Iwamura, H. *Inorg. Chem.* **1998**, *37*, 2273. (d) Iwamura, H.; Inoue, K.; Koga, N. *New J. Chem.* **1998**, 201. (e) Rabu, P.; Drillon, M.; Iwamura, H.; Gorlitz, G.; Itoh, T.; Matsuda, K.; Koga, N.; Inoue, K. *Eur. J. Inorg. Chem.* **2000**, 211. (f) Kanegawa, S.; Karasawa, S.; Nakano, M.; Koga, N. *Chem. Commun.* **2004**, 1750. (g) Laukhin, V.; Martinez, B.; Fontchberta, J.; Amabilino, D. B.; Minguet, M.; Veciana, J. *J. Phys. Chem.* **2004**, *108*, 18441.
- (6) (a) Koga, N.; Iwamura, H. In *Carbene Chemistry: From Fleeting Intermediates to Powerful Reagents*; Bertrand, G., Ed.; FontisMedia: Lausanne, Switzerland, 2002; pp 271–296. (b) Matsuda, K.; Nakamura, N.; Takahashi, K.; Inoue, K.; Koga, N.; Iwamura, H. In *Molecule-based Magnetic Materials: Theory, Techniques, and Applications*; Turnbull, M. M., Sugimoto, T., Thompson, L. K., Eds.; ACS Symposium Series 644; American Chemical Society: Washington, DC, 1996; p 142.
- (7) (a) Nakamura, N.; Inoue, K.; Iwamura, H.; Fujioka, T.; Sawaki, Y. *J. Am. Chem. Soc.* **1992**, *114*, 1484. (b) Nakamura, N.; Inoue, K.; Iwamura, H. *Angew. Chem., Int. Ed. Engl.* **1993**, *32*, 872. (c) Matsuda, K.; Nakamura, N.; Takahashi, K.; Inoue, K.; Koga, N.; Iwamura, H. *J. Am. Chem. Soc.* **1995**, *117*, 5550. (d) Matsuda, K.; Nakamura, N.; Inoue, K.; Koga, N.; Iwamura, H. *Chem.-Eur. J.* **1996**, *2*, 259. (e) Matsuda, K.; Nakamura, N.; Inoue, K.; Koga, N.; Iwamura, H. *Bull. Chem. Soc. Jpn.* **1996**, *69*, 1483.
- (8) For reviews of general reactions of carbenes, see: (a) Kirmse, W. *Carbene Chemistry*, 2nd ed.; Academic Press: New York, 1971. (b) *Carbenes*; Moss, R. A., Jones, M., Jr., Eds.; Wiley: New York, 1973 and 1975; Vols. 1 and 2. (c) *Carbene(oid), Carbene*; Regitz, M., Ed.; Thieme: Stuttgart, 1989. (d) Wentrup, C. *Reactive Intermediates*; Wiley: New York, 1984; pp 162–264.
- (9) (a) Tomioka, H. *Acc. Chem. Res.* **1997**, *30*, 315. (b) Tomioka, H. In *Advances in Carbene Chemistry*; Brinker, U., Ed.; JAI Press: Greenwich, CT, 1998; Vol. 2, pp 175–214. (c) Tomioka, H. In *Carbene Chemistry*; Bertrand, G., Ed.; FontisMedia: Lausanne, Switzerland, 2002; pp 103–152.
- (10) (a) Tomioka, H.; Nakajima, J.; Mizuno, H.; Iiba, E.; Hirai, K. *Can. J. Chem.* **1999**, *77*, 1066. (b) Itakura, H.; Tomioka, H. *Org. Lett.* **2000**, *2*, 2995. (c) Takahashi, Y.; Tomura, M.; Yoshida, K.; Murata, S.; Tomioka, H. *Angew. Chem., Int. Ed.* **2000**, *39*, 3478. (d) Tomioka, H.; Iwamoto, E.; Itakura, H.; Hirai, K. *Nature* **2001**, *412*, 626. (e) Iwamoto, E.; Hirai, K.; Tomioka, H. *J. Am. Chem. Soc.* **2003**, *125*, 14664. (f) Yoshida, K.; Iiba, E.; Nozaki, Y.; Hirai, K.; Takahashi, Y.; Tomioka, H.; Lin, C.-T.; Gaspar, P. *Bull. Chem. Soc. Jpn.* **2004**, *77*, 1509.
- (11) Regitz, M.; Maas, G. *Diazo Compounds: Properties and Synthesis*; Academic Press: Orlando, FL, 1986.

- (12) Tomioka, H.; Hattori, M.; Hirai, K.; Sato, K.; Shiomi, D.; Takui, T.; Itoh, K. *J. Am. Chem. Soc.* **1998**, *120*, 1106.
- (13) (a) Furukawa, K.; Takui, T.; Itoh, K.; Miyahara, I.; Hirotsu, K.; Watanabe, T.; Hirai, K.; Tomioka, H. *Synth. Met.* **1997**, *85*, 1330. (b) Itoh, T.; Hirai, K.; Tomioka, H. *J. Am. Chem. Soc.* **2001**, *126*, 1130. (c) Itoh, T.; Morisaki, F.; Kurono, M.; Hirai, K.; Tomioka, H. *J. Org. Chem.* **2004**, *69*, 5870. (d) Ohtsuka, Y.; Itoh, T.; Hirai, K.; Tomioka, H.; Takui, T. *Org. Lett.* **2004**, *6*, 847. (e) Itoh, T.; Maemura, T.; Ohtsuka, Y.; Ikari, Y.; Wildt, H.; Hirai, K.; Tomioka, H. *Eur. J. Org. Chem.* **2004**, 2991. (f) Morisaki, F.; Kurono, M.; Hirai, K.; Tomioka, H. *Org. Biomol. Chem.* **2005**, *3*, 431. (g) Itoh, T.; Jinbo, Y.; Hirai, K.; Tomioka, H. *J. Am. Chem. Soc.* **2005**, *127*, 1650.
- (14) (a) Koga, N.; Iwamura, H. In *Molecular Magnetism in Organic-Based Materials*; Lahti, P. M., Ed.; Marcel Dekker: New York, 1999; pp 629–659. (b) Koga, N.; Iwamura, H. *Mol. Cryst. Liq. Cryst.* **1997**, *305*, 415. (c) Iwamura, H.; Koga, N. *Mol. Cryst. Liq. Cryst.* **1999**, *334*, 437. (d) Iwamura, H.; Koga, N. *Pure Appl. Chem.* **1999**, *71*, 231.
- (15) (a) Lehn, J.-M. *Supramolecular Chemistry: Concepts and Perspectives*; VCH: Weinheim, Germany, 1995. (b) Nierengarten, J.-F.; Dietrich-Buchecker, C. O.; Sauvage, J.-P. *J. Am. Chem. Soc.* **1994**, *116*, 375. (c) Leininger, J.-F.; Olenyuk, B.; Stang, P. J. *Chem. Rev.* **2000**, *100*, 853.

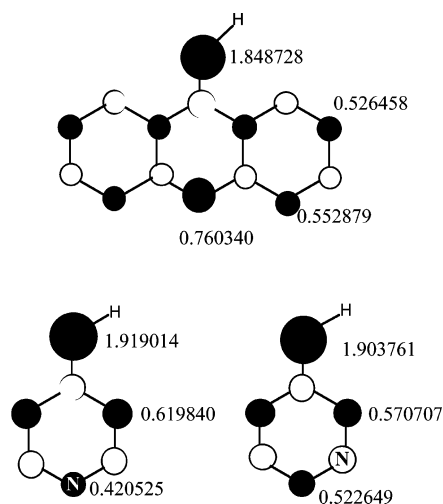

**Figure 1.**  $\pi$ -Spin density distribution of triplet anthrylcarbene and triplet 4- and 3-pyridylcarbene by PM3 method. The vacant and filled circles denote negative and positive spin densities, respectively.

*tert*-butylphenyl)-9-anthryl]carbene **1** as a triplet carbene unit to construct a high heterospin system since this carbene has the longest lifetime (more than 10 days) in solution at room temperature.<sup>10e</sup> Thus, we needed to introduce pyridyl groups onto the precursor of **1**, that is, bis[10-(2,6-dimethyl-4-*tert*-butylphenyl)-9-anthryl]diazomethane **1-N<sub>2</sub>**.

Before preparing a desired precursor, we need to consider the spin densities of organic spin sources and connecting ligands. A pyridyl group ligand needs to be introduced on a carbon that has nonbonding molecular orbital (NBMO) spin densities.<sup>16,17</sup> The  $\pi$ -spin density distribution of triplet anthrylcarbene was calculated using the PM3 method and is shown in Figure 1. The largest spin density is found at position 10.

However, it is likely that aryl groups at this position are not in the same plane as the anthryl group, due to repulsion by peri hydrogens. For instance, the ESR zero-field splitting (ZFS) parameters change very little between bis(9-anthryl)carbene and its 10-phenylated analogue.<sup>10</sup> Positions 2 (and 7) and 4 (and 5) have significantly high-spin densities, but from a synthetic standpoint, position 2 (and 7) is more realistic. The spin densities at the bridging groups are also important factors to take into account. The  $\pi$ -spin density distribution of the isomeric carbenes 3- and 4-pyridylcarbene calculated by PM3 (Figure 1) suggest that, while in the para isomer 4-pyridylcarbene, the pyridyl nitrogen atom is expected to have nonzero NBMO coefficients, and hence the spin interactions are expected to be transmitted effectively through the nitrogen coordinated to the metal ions, zero NBMO coefficients are expected on the pyridyl nitrogen atom in the meta isomer 3-pyridylcarbene, and hence the magnitude of the spin interactions is expected to be small.

On the basis of the above considerations, we decided to prepare two dianthryldiazomethanes having two pyridyl groups at either the 2,2'- or the 2,7-positions, that is, bis[10-(4-*tert*-butyl-2,6-dimethylphenyl)-2-(4-pyridyl)-9-anthryl]diazomethane (2,2'-DPy-**1-N<sub>2</sub>**) and [10-(4-*tert*-butyl-2,6-dimethyl-

phenyl)-9-anthryl][10-(4-*tert*-butyl-2,6-dimethylphenyl)-2,7-di(4-pyridyl)-9-anthryl]diazomethane (2,7-DPy-**1-N<sub>2</sub>**).

We first attempted to introduce a pyridyl group by direct coupling of the corresponding diazo compound bearing bromo groups (e.g., 2,2'-DBr-**1-N<sub>2</sub>**) with pyridylboronic acid under Suzuki coupling conditions,<sup>18</sup> but all attempts were unsuccessful.

However, the coupling reaction of the precursory carbamate took place smoothly to give bis[10-(4-*tert*-butyl-2,6-dimethylphenyl)-2-(4-pyridyl)-9-anthryl]methylcarbamate, which was converted to the corresponding diazo compound (2,2'-DPy-**1-N<sub>2</sub>**) by a routine method (Scheme 2).

Later, we found that direct coupling was achieved by using the corresponding iodinated diazo compound (e.g., 2,7-DI-**1-N<sub>2</sub>**). Thus, 2,7-DPy-**1-N<sub>2</sub>** was prepared by this method (Scheme 3).

All diazo compounds were purified by repeated chromatography on a gel permeation column, and a rather stable red solid was obtained.

**(A) Spectroscopic Studies of Photoproducts of DPy-**1-N<sub>2</sub>**** Before examining the magnetic properties of the species generated by photolysis of the complex between the desired diazo compound DPy-**1-N<sub>2</sub>** and metal ions, we characterized the metal-free carbene DPy-**1**.

**Electron Spin Resonance (ESR) Studies.** Irradiation ( $\lambda > 350$  nm) of 2,7-DPy-**1-N<sub>2</sub>** ( $1.2 \times 10^{-2}$  M) in 2-methyltetrahydrofuran (2-MTHF) at 77 K gave ESR signals of randomly oriented triplet molecules (Figure 2a). The spectrum showing unresolved *x* and *y* lines and a rather intense line at 152 mT corresponding to  $\Delta m_s = 2$  is very similar to that recorded for the "parent" triplet carbene before pyridination, bis[10-(4-*tert*-butyl-2,6-dimethylphenyl)-9-anthryl]carbene **1**,<sup>10d,e</sup> and can hence be assigned to triplet [10-(4-*tert*-butyl-2,6-dimethylphenyl)-9-anthryl][10-(4-*tert*-butyl-2,6-dimethylphenyl)-2,7-di(4-pyridyl)-9-anthryl]carbene (2,7-DPy-**31**) generated by photodissociation of 2,7-DPy-**1-N<sub>2</sub>**. The signals were analyzed in terms of ZFS parameters with  $D = 0.0978$  cm<sup>-1</sup> and  $E = 0.0029$  cm<sup>-1</sup> ( $E/D = 0.030$ ).

Similar irradiation of 2,2'-DPy-**1-N<sub>2</sub>** under identical conditions also gave ESR signals due to the triplet carbene 2,2'-DPy-**31**, which were analyzed in terms of ZFS parameters with  $D = 0.113$  cm<sup>-1</sup> and  $E = 0.0021$  cm<sup>-1</sup> ( $E/D = 0.0189$ ) (Figure S1).

It is interesting to note that the *D* value of 2,7-DPy-**31** is slightly smaller than that reported for the "parent" triplet carbene **31** ( $D = 0.102$  cm<sup>-1</sup> and  $E = 0.0008$  cm<sup>-1</sup>,  $E/D = 0.0079$ ). This suggests that the unpaired electrons are delocalized to pyridyl groups at the 2 and 7 positions to some extent. However, the *D* value of 2,2'-DPy-**31** is very similar to that of **31**, suggesting that delocalization is not significant in this case.

To examine the stability of triplet carbenes, a variable-temperature ESR study was carried out. The thermal stability of the triplet carbenes could be estimated by gradually warming the matrix containing triplet carbenes to a desired temperature, followed by letting it stand at this temperature for 5 min, and then recooling it to 77 K to measure the signal. This procedure

(16) Borden, W. T.; Davidson, E. R. *J. Am. Chem. Soc.* **1977**, *99*, 4587.

(17) (a) Borden, W. T.; Iwamura, H.; Berson, J. A. *Acc. Chem. Res.* **1994**, *27*, 109. (b) Borden, W. T. In *Diradicals*; Borden, W. T., Ed.; Wiley-Interscience: New York, 1982; pp 1–12.

(18) For reviews, see for example: (a) Suzuki, A. In *Metal-Catalyzed Cross-Coupling Reactions*; Diederich, F., Stang, P. J., Eds.; Wiley-VCH: Weinheim, Germany, 1998; pp 49–97. (b) Stanforth, S. P. *Tetrahedron* **1998**, *54*, 263. (c) Miyaura, N.; Suzuki, A. *Chem. Rev.* **1995**, *95*, 2457.



Scheme 2

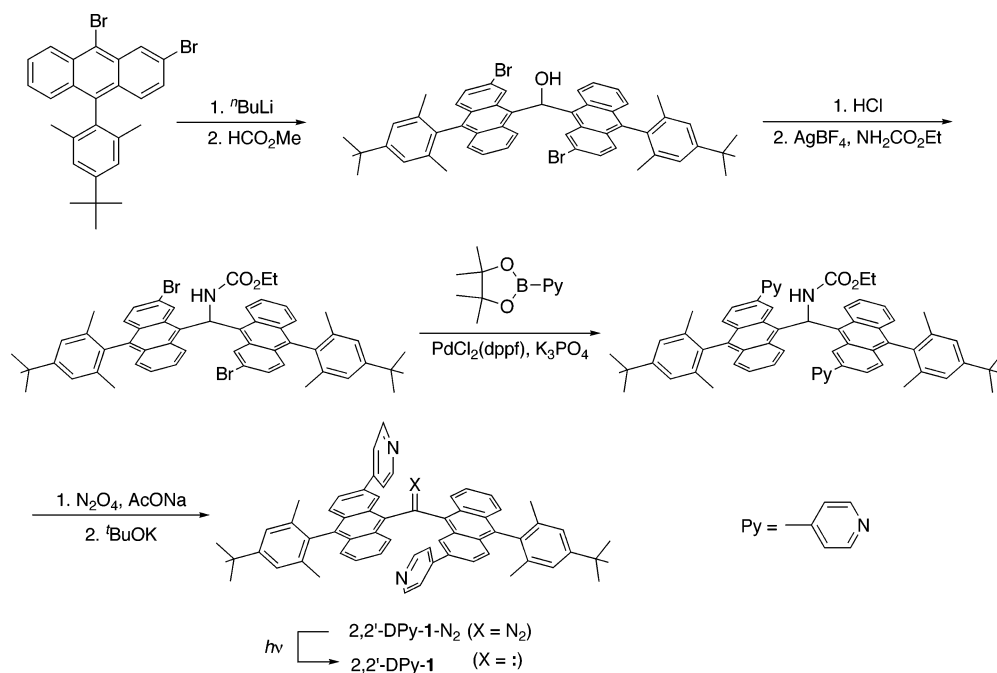

Scheme 3

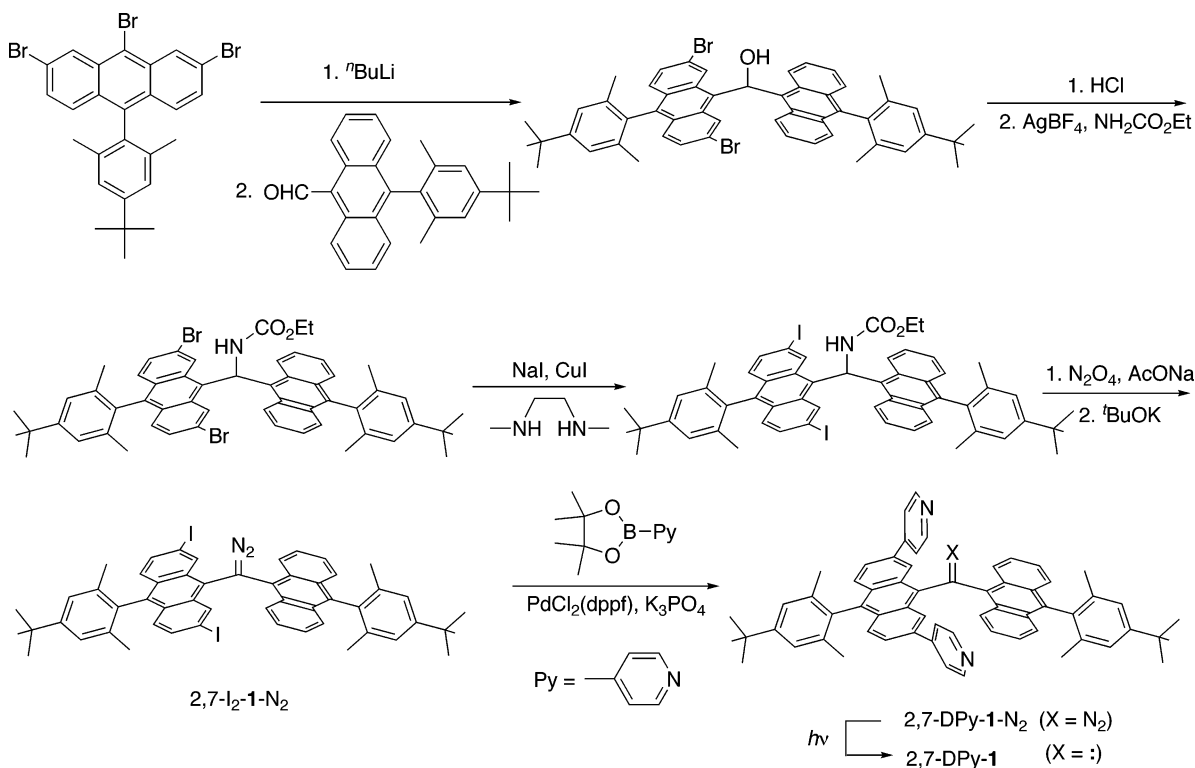

can compensate for weakening of signals due to Curie's law.<sup>19</sup> When the samples containing 2,7-DPy-1 were gradually warmed, the signals became sharp around 90 K, a small shift in the  $z$  lines was observed, and a small but distinct decrease in the  $D$  value was noted ( $D = 0.0813 \text{ cm}^{-1}$  and  $E = 0.0007 \text{ cm}^{-1}$ ,  $E/D = 0.0092$ ) (Figure 2b). These changes were not reversible; when

the sample was recooled to 77 K, no change took place apart from an increase in the signal intensity according to Curie's law.

A similar sharpening of the signals and decrease in ZFS parameters was noted for 2,2'-DPy-3<sup>1</sup> ( $D = 0.0831 \text{ cm}^{-1}$  and  $E = 0.0007 \text{ cm}^{-1}$ ,  $E/D = 0.0087$ ).

A decrease in the  $D$  and  $E$  values upon annealing of the matrix has often been observed for sterically congested triplet diaryl-carbenes and is usually interpreted in terms of geometrical changes.<sup>20–22</sup>

(19) (a) Platz, M. S. In *Diradicals*; Borden, W. T., Ed.; Wiley: New York, 1982; pp 195–258. (b) Wasserman, E.; Hutton, R. S. *Acc. Chem. Res.* **1977**, *10*, 27. (c) Breslow, R.; Chang, H. W.; Wasserman, E. *J. Am. Chem. Soc.* **1967**, *89*, 1112.

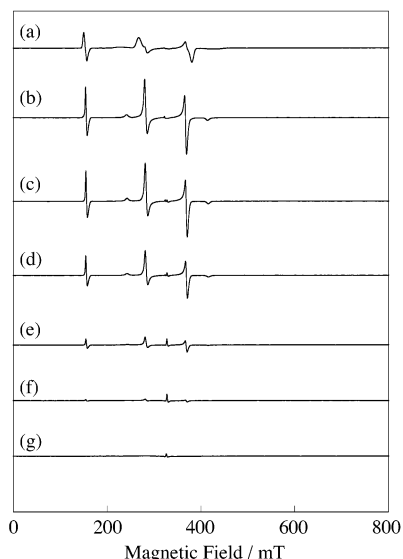

**Figure 2.** (a) ESR spectra obtained by irradiation of 2,7-DPy-1-N<sub>2</sub> ( $1.2 \times 10^{-2}$  M) in 2-methyltetrahydrofuran at 77 K. (b–g) ESR spectra observed at 77 K in 2-methyltetrahydrofuran after warming the matrix containing 2,7-DPy-<sup>3</sup>1 to (b) 90, (c) 220, (d) 240, (e) 260, (f) 280, and (g) 300 K.

Thus, when a carbene is generated in a rigid matrix at a very low temperature, it should have the geometry dictated by that of its precursor. Even if the thermodynamically most stable geometry of the carbene is different from its initial geometry, the rigidity of the matrixes prevents the carbene from achieving its minimum-energy geometry. When the matrix is softened by annealing, the carbene undergoes relaxation to the preferred geometry, probably to decrease steric compression.<sup>21,22</sup> It has been shown that the ZFS parameters of sterically unperturbed diarylcarbenes show little sensitivity toward the temperature of the matrix.<sup>20</sup> The rather small *D* values coupled with the essentially zero *E* value observed for <sup>3</sup>1 indicate that there is extensive delocalization of the unpaired electrons into the anthryl portions and that the carbene has a substantial degree of allenic character.<sup>10</sup> A small but distinct decrease in the *D* value upon annealing of the matrix can thus be interpreted as indicating that the triplet carbene relaxed to a nearly linear geometry, in which the unpaired electrons are further delocalized into the anthryl portions. The *E* values also decreased accordingly.

Significant decay of the signals due to 2,7-DPy-1 was observed only at 280 K, and the signals were observable even at 300 K (Figure 2c–f). However, the signals disappeared completely after the sample had stood at room temperature for 15 min (the measurements were made at 77 K). An essentially identical thermal stability was observed for 2,2'-DPy-1 (Figure S1).

This result can be compared with that observed for <sup>3</sup>1, where the ESR signals were observed even after standing for 3 h at room temperature.<sup>10e</sup> A marked decrease in the thermal stability was thus noted once pyridyl groups were introduced at the 2 (and 7) positions of **1**.

**UV–Visible (UV–Vis) Spectroscopic Studies in a Matrix at Low Temperature.** Optical spectroscopical monitoring in the frozen medium gave analogous results. Irradiation of the diazo compound (2,7-DPy-1-N<sub>2</sub>) ( $1.5 \times 10^{-4}$  M) in a 2-MTHF matrix at 77 K resulted in rapid disappearance of the original absorption due to 2,7-DPy-1-N<sub>2</sub> and concurrent growth of sharp and strong absorption bands at 363, 427, and 501 nm (Figure 3Ab). Since ESR signals ascribable to the triplet carbene are observed under identical conditions, the absorption spectrum can be safely assigned to the triplet carbene 2,7-DPy-<sup>3</sup>1. When the matrix was gradually warmed, the bands at 501 nm became sharper and shifted to 469 nm and the bands at 427 nm shifted to 420 nm, with a spike at 441 nm at around 90 K (Figure 3Ac). This change can be attributed to the geometrical change in the triplet carbene associated with a change in the viscosity of the matrix upon annealing, as shown by ESR experiments. Upon further thawing, the band started to disappear slowly at around 200 K, and it disappeared completely after standing for 1 h at 300 K (Figure 3B).

Similar irradiation of 2,2'-DPy-1-N<sub>2</sub> at 77 K also gave absorption bands at 399, 420, 454, and 504 nm due to 2,2'-DPy-<sup>3</sup>1 before relaxation and those at 395 and 469 nm due to the relaxed one at 90 K. The bands also started to disappear at around 260 K but were still observable at 300 K (Figure S2).

Once again, these results can be compared with those observed for <sup>3</sup>1, which exhibited essentially identical absorption bands (360, 382, 405, 438, and 472 nm at 77 K and 360, 380, 410, 438, and 452 nm at 90 K) but showed distinctly greater thermal stability, surviving several hours at 300 K.<sup>10e</sup>

Again, a marked decrease in the thermal stability was noted once pyridyl groups were introduced at the 2 and 7 positions of **1**.

**Time-Resolved UV–Vis Spectroscopic Study in Solution at Room Temperature.** To determine the stabilities of the present carbenes more accurately, their lifetimes were estimated in degassed benzene at room temperature. We had previously measured the lifetimes of a series of sterically congested diarylcarbenes under these conditions.<sup>9</sup> The lifetimes of the present carbenes were too long to monitor by laser flash photolysis, which is routinely used in such studies. Therefore, we used conventional UV–vis spectroscopy.

Brief irradiation of the diazo compound (2,7-DPy-1-N<sub>2</sub>) ( $1.5 \times 10^{-5}$  M) in degassed benzene at 25 °C with a 70–90 mJ, 308-nm pulse from a XeCl excimer laser produced transient absorption bands showing strong maxima at 360, 411, and 467 nm, which appeared coincidentally with the pulse (Figure 4). These transient absorption bands are essentially the same as those observed for the photolysis of 2,7-DPy-1-N<sub>2</sub> in a 2-MTHF matrix at 77 K, followed by warming to 100 K. Thus, we assigned the transient product as 2,7-DPy-<sup>3</sup>1 in its geometrically relaxed state. This assignment was supported by trapping experiments (vide infra). The absorption bands decayed very slowly, and the transient bands did not disappear completely, even after standing for several hours under these conditions. The decay was best analyzed in terms of a

- (20) For reviews of the EPR spectra of triplet carbenes, see: (a) Sander, W.; Bucher, G.; Wierlacher, S. *Chem. Rev.* **1993**, *93*, 1583. (b) Trozzolo, A. M.; Wasserman, E. In *Carbenes*; Jones, M., Jr., Moss, R. A., Eds.; Wiley: New York, 1975; Vol. 2, pp 185–206.
- (21) (a) Tukada, H.; Sugawara, T.; Murata, S.; Iwamura, H. *Tetrahedron Lett.* **1986**, *27*, 235. (b) Nazran, A. S.; Gabe, F. J.; LePage, Y.; Northcott, D. J.; Park, J. M.; Griller, D. *J. Am. Chem. Soc.* **1983**, *105*, 2912. (c) Nazran, A. S.; Griller, D. *J. Chem. Soc., Chem. Commun.* **1983**, 850. (d) Gilbert, B. C.; Griller, D.; Nazran, A. S. *J. Org. Chem.* **1985**, *50*, 4738. (e) Nazran, A. S.; Lee, F. L.; LePage, Y.; Northcott, D. J.; Park, J. M.; Griller, D. *J. Phys. Chem.* **1984**, *88*, 5251. (f) Tomioka, H.; Watanabe, T.; Hirai, K.; Furukawa, K.; Takui, T.; Itoh, K. *J. Am. Chem. Soc.* **1995**, *117*, 6376.
- (22) See for review: Tomioka, H. In *Advances in Strained and Interesting Organic Molecules*; Halton, B., Ed.; JAI Press: Greenwich, CT, 2000; Vol. 8, pp 83–112.

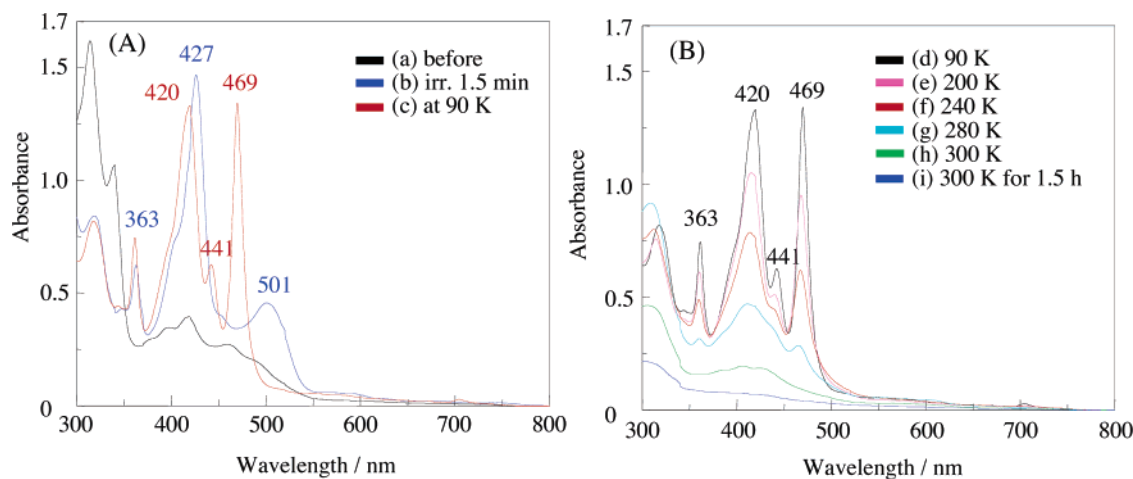

**Figure 3.** UV-vis spectra obtained by irradiation of diazo compound 2,7-DPy-1-N<sub>2</sub> ( $1.5 \times 10^{-4}$  M). (A) (a) Spectra of 2,7-DPy-1-N<sub>2</sub> in 2-methyltetrahydrofuran at 77 K. (b) The same sample after irradiation (1.5 min,  $\lambda > 350$  nm). (c) The same sample after thawing to 90 K. (B) UV-vis spectral change measured upon warming the same sample from 90 to 300 K.

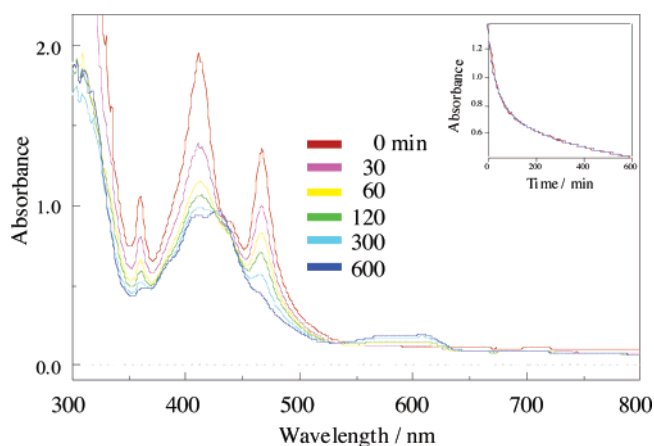

**Figure 4.** Absorption of transient products formed during irradiation of diazo compound 2,7-DPy-1-N<sub>2</sub> ( $1.5 \times 10^{-5}$  M) in degassed benzene at room temperature recorded 0, 30, 60, 120, 300, and 600 min after excitation. Inset shows the time course of the absorbance at 467 nm.

combination of first-order kinetics with  $k = 6 \times 10^{-4} \text{ min}^{-1}$ ,  $\tau = 1.6 \times 10^3 \text{ min}$  (28 h), OD = 0.564 and second-order kinetics with  $2k/\epsilon l = 3.6 \times 10^{-2} \text{ min}^{-1}$ ,  $t_{1/2} = 135 \text{ min}$ , OD = 0.803.<sup>23</sup>

When LFP was carried out on a nondegassed benzene solution of 2,7-DPy-1-N<sub>2</sub> ( $5.0 \times 10^{-5}$  M), the half-life of 2,7-DPy-<sup>3</sup>1 decreased dramatically, and a broad absorption band with a maximum at 420 nm appeared at the expense of the absorption due to 2,7-DPy-<sup>3</sup>1 (Figure S3). The spent solution was found to contain the corresponding ketone 2,7-DPy-1-O.

It is well-documented<sup>24,25</sup> that diarylcarbenes with triplet ground states are readily trapped by oxygen to generate the corresponding diaryl ketone oxides, which are easily observed directly either by matrix isolation or by flash photolysis and

#### Scheme 4

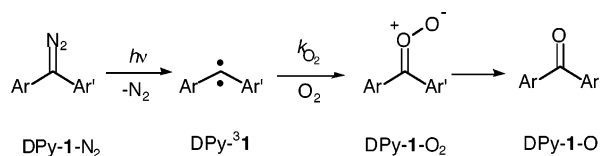

show a broad absorption band centered at 396–450 nm. Thus, the observations can be interpreted as indicating that 2,7-DPy-<sup>3</sup>1 is trapped by oxygen to form the carbonyl oxide (2,7-DPy-1-O<sub>2</sub>), which confirms that the transient absorption quenched by oxygen is due to 2,7-DPy-<sup>3</sup>1 (Scheme 4).

The apparent buildup rate constant,  $k_{\text{obs}}$ , of the carbonyl oxide (2,7-DPy-1-O<sub>2</sub>) is essentially identical to that for the decay of 2,7-DPy-<sup>3</sup>1, and  $k_{\text{obs}}$  is expressed as given in eq 1:

$$k_{\text{obs}} = k_0 + k_{\text{O}_2} [\text{O}_2] \quad (1)$$

where  $k_0$  represents the rate of decay of 2,7-DPy-<sup>3</sup>1 in the absence of oxygen and  $k_{\text{O}_2}$  is the rate constant for the quenching of 2,7-DPy-<sup>3</sup>1 by oxygen. A plot of the observed pseudo-first-order rate constant of the formation of the oxide against [O<sub>2</sub>] is linear (Figure S3). From the slope of this plot,  $k_{\text{O}_2}$  was determined to be  $1.4 \times 10^5 \text{ M}^{-1} \text{ s}^{-1}$ .

Similar irradiation of 2,2'-DPy-1-N<sub>2</sub> ( $5.0 \times 10^{-5}$  M) in degassed benzene also gave transient bands at 392 and 465 nm due to 2,2'-DPy-<sup>3</sup>1 in its relaxed state (Figure S4). The transient band was found to be second-order ( $2k/\epsilon l = 2.4 \times 10^{-2} \text{ min}^{-1}$ ) in this case. The approximate half-life ( $t_{1/2}$ ) of 2,7-DPy-<sup>3</sup>1 was estimated to be 35 min. The transient bands showed that 2,7-DPy-<sup>3</sup>1 was also trapped with oxygen with a rate constant of  $9.0 \times 10^4 \text{ M}^{-1} \text{ s}^{-1}$  (Figure S5).

These compounds are shorter-lived than <sup>3</sup>1, whose half-life under identical conditions is estimated to be 14.5 days.<sup>10e</sup> However, the quenching rate constants by oxygen are approximately 5 orders of magnitude smaller than that of triplet diphenylcarbene<sup>25</sup> and are similar to that of <sup>3</sup>1 ( $k_{\text{O}_2} = 5.5 \times 10^4 \text{ M}^{-1} \text{ s}^{-1}$ ). Thus, they are still fairly stable for triplet carbenes.

**(B) Spectroscopic Studies of Photoproducts of Complex between DPy-1-N<sub>2</sub> and Cu(hfac)<sub>2</sub>.** All the above observations

(23) The decay curves were analyzed by the following equation:  $k_0 \exp(-k_1 t) + 1/(1/k_2 + k_3 t)$ , where  $k_0$  and  $k_2$  are absorbances of components decaying in the first- and second-order kinetics at  $t = 0$  time, respectively, and  $k_1$  and  $k_3$  are the decay rates of the first- and second-order kinetics, respectively. The analysis was made by using Igor Pro 4 (WaveMetrics, Inc).

(24) See for review: (a) Sander, W. *Angew. Chem., Int. Ed. Engl.* **1990**, *29*, 344. (b) Bunnelle, W. *Chem. Rev.* **1991**, *91*, 336.

(25) Scaiano, J. C.; McGimpsey, W. G.; Casal, H. L. *J. Org. Chem.* **1989**, *54*, 1612.



## Scheme 5

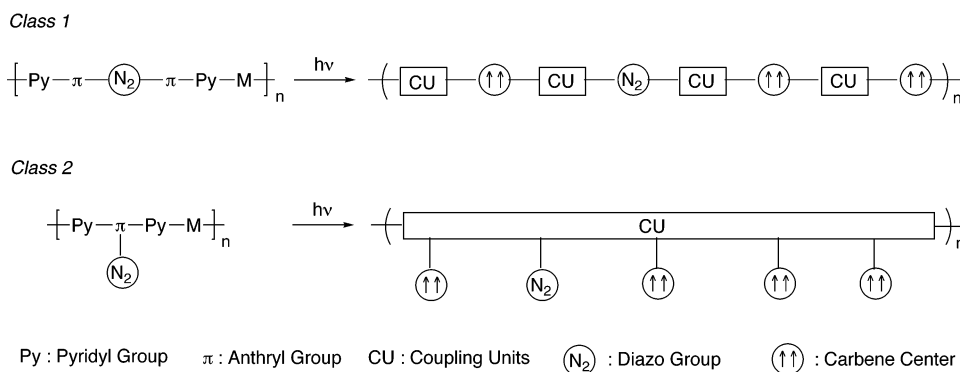

suggest that we now have a fairly persistent triplet carbene unit that has a pyridine ligand that is bridgeable with coordinatively unsaturated metal ions. The next step is to characterize the magnetic properties of the photoproducts of the complex between DPy-1-N<sub>2</sub> and metal ions.

It has been demonstrated that the sign and magnitude of the exchange coupling between metal ions and organic radicals depend not only on the periodicity of the ligand  $\pi$  orbitals, but also on the orbitals occupied by the unpaired d electrons of the metal ions.<sup>14a</sup> For instance, ferromagnetic interaction is observed between the carbenes and the copper ions in the [Cu(hfac)<sub>2</sub>(DPy)] (hfac = hexafluoroacetylacetonate) system, while anti-ferromagnetic interaction is observed between the carbenes and the manganese ions in the [Mn(hfac)<sub>2</sub>(DPy)] system. This is explained in terms of the difference between the overlapping mode of the magnetic orbitals in the metal ions and those in the nitrogen atom on the pyridine ligands. Thus, we chose Cu(hfac)<sub>2</sub> as the metal ion to generate high-spin states.

Both diazo compounds are expected to form a chain as a result of complexation with metal ions (to form -DPy-1-N<sub>2</sub>-M-), and the chain is expected, upon irradiation, to generate a polycarbene chain (-DPy-1-M-) in which the spins on the chain start to interact ferromagnetically. However, there is a potential difference between the two in the connectivity of the ferromagnetic coupling unit with respect to carbene centers (Scheme 5). In the -2,2'-DPy-1-M- chain, for instance, carbene centers are involved in coupling units in the chain (Class 1 in Scheme 5), while in the -2,7-DPy-1-M- chain, carbenes are attached as pendants to a coupling unit of the chain (Class 2 in Scheme 5). In other words, failure to generate a carbene (a chemical defect) in the interior of a polycarbene chain may interrupt the exchange pathway in the former, while this chemical defect may be circumvented in the latter.<sup>4</sup>

**ESR Studies.** Solutions of 2,2'-DPy-1-N<sub>2</sub> ( $11.6 \times 10^{-3}$  M) in 2-MTHF and copper bis(hexafluoroacetylacetonate) Cu(hfac)<sub>2</sub> ( $11.6 \times 10^{-3}$  M) in 2-MTHF were mixed in a 1:1 molar ratio at room temperature, and the mixture was allowed to stand overnight. The solution was then placed in the cryostat of a low-temperature ESR cavity. Before irradiation, the solution showed ESR signals at 260, 276, 298, 312, and 320 mT, which is characteristic of the magnetic orbital  $d_x^2-y^2$  of the Cu(II) ion<sup>26</sup> of Cu(hfac)<sub>2</sub> (Figure 5Aa). When the solution was irradiated ( $\lambda > 350$  nm) at 77 K, the signals due to the isolated Cu(II) ion in the Cu(hfac)<sub>2</sub> unit started to decrease, and rather broad signals gradually appeared at 340 mT, with a sharp one at 314 mT, at

the expense of the Cu(II) signals (Figure 5Ab and c). Similar ESR spectral changes have been observed for the 2:1 complex of (phenyl)(4-pyridyl)carbene with a Cu(II) ion, which has been shown to have ferromagnetic interaction between the carbene and the copper ion. Thus it is suggested that the generated carbene centers interacted magnetically with the Cu(II) ion to form a high-spin species.<sup>14a,27</sup> As no significant signals due to the isolated triplet carbene 2,2'-DPy-<sup>3</sup>1 were observed, it is suggested that the pyridine moiety binds with Cu(hfac)<sub>2</sub> in a nearly quantitative manner under these cryogenic conditions. However, it should be noted that the signals due to the isolated Cu(II) ion did not disappear completely, even after prolonged irradiation.

To estimate the thermal stability of the signals, the sample was warmed to a desired temperature, allowed to stand at this temperature for 5 min, and then recooled to 77 K to measure the ESR signals. The new signals increased up to a temperature of 100 K, but started to disappear at 240 K. At around 260 K, the signals due to the isolated Cu(II) ion started to recover, and they completely replaced the signals due to the complex at around 300 K (Figure 5B).

Similar irradiation of the 1:1 complex of 2,7-DPy-1-N<sub>2</sub> and Cu(hfac)<sub>2</sub> gave somewhat different results (Figure 6). Before irradiation, the solution showed only broad ESR signals at 309 and 319 mT, without showing the characteristic signal of the Cu(II) ion of Cu(hfac)<sub>2</sub> (Figure 6Aa). This is most probably because the 3d spins on the Cu(II) ions in the complex can already interact with each other, through the pyridyl and anthryl aromatic  $\pi$  networks, since they are conjugatively involved in the ferromagnetic chains (Scheme 5). Upon irradiation, the signal at 309 mT started to increase, with a concomitant shift of the signal maximum, until the maximum stopped growing at 315 mT, while the signal at 319 mT decreased initially, but then also increased with a concomitant shift of the signal, until the maximum stopped growing at 325 mT, after irradiation for 1 h (Figure 6Ac). Again, the fact that no significant signals due to the isolated triplet carbene 2,7-DPy-<sup>3</sup>1 were observed suggests that the pyridine moiety binds with Cu(hfac)<sub>2</sub> in a nearly quantitative manner under these cryogenic conditions.

- (27) (a) Sano, Y.; Tanaka, M.; Koga, N.; Matsuda, K.; Iwamura, H.; Rabu, P.; Drillon, M. *J. Am. Chem. Soc.* **1997**, *119*, 8246. (b) Karasawa, S.; Koga, N. *Polyhedron* **2001**, *20*, 1387. (c) Karasawa, S.; Sano, Y.; Akita, T.; Koga, N.; Itoh, T.; Iwamura, H.; Rabu, P.; Drillon, M. *J. Am. Chem. Soc.* **1998**, *120*, 10080. (d) Karasawa, S.; Kumada, H.; Koga, N.; Iwamura, H. *J. Am. Chem. Soc.* **2001**, *123*, 9685. (e) Morikawa, H.; Imamura, F.; Tsurukami, Y.; Itoh, T.; Kumada, H.; Karasawa, S.; Koga, N.; Iwamura, H. *J. Mater. Chem.* **2001**, *11*, 493. (f) Karasawa, S.; Koga, N. *Polyhedron* **2003**, *22*, 1877.

(26) Sugiura, Y. *Inorg. Chem.* **1978**, *17*, 2178.

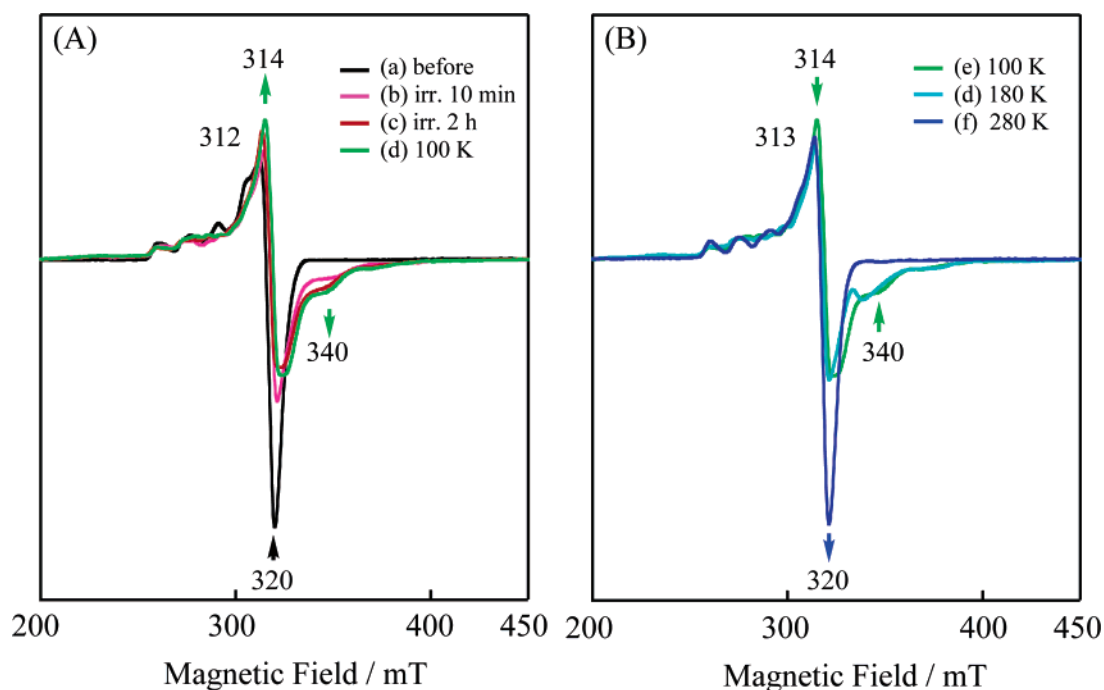

**Figure 5.** ESR spectra obtained by irradiation of 1:1 mixture ( $5.8 \times 10^{-3}$  M) of 2,2'-DPy-1-N<sub>2</sub> and Cu(hfac)<sub>2</sub> in 2-methyltetrahydrofuran. (A) Spectra of 1:1 mixture ( $5.8 \times 10^{-3}$  M) of 2,2'-DPy-1-N<sub>2</sub> and Cu(hfac)<sub>2</sub> in 2-MTHF (a) before irradiation and (b–c) after irradiation ( $\lambda > 350$  nm) for 10 and 120 min at 77 K and (d) the same sample measured at 77 K after warming to 100 K. (B) ESR spectra observed at 77 K after warming to (e) 100, (f) 180, and (g) 280 K.

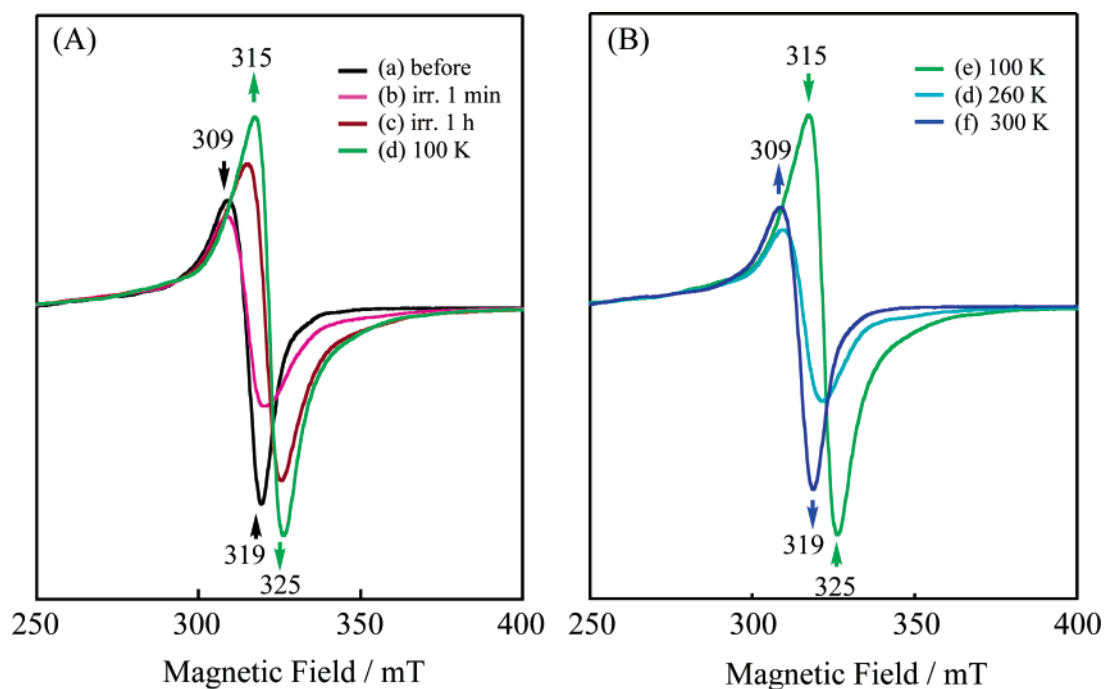

**Figure 6.** ESR spectra obtained by irradiation of 1:1 mixture ( $5.8 \times 10^{-3}$  M) of 2,7-DPy-1-N<sub>2</sub> and Cu(hfac)<sub>2</sub> in 2-methyltetrahydrofuran. (A) Spectra of 1:1 mixture ( $5.8 \times 10^{-3}$  M) of 2,7-DPy-1-N<sub>2</sub> and Cu(hfac)<sub>2</sub> in 2-MTHF (a) before irradiation and (b–c) after irradiation ( $\lambda > 350$  nm) for 1 and 60 min at 77 K and (d) the same sample measured at 77 K after warming to 100 K. (B) ESR spectra observed at 77 K after warming to (e) 100, (f) 260, and (g) 300 K.

Upon warming the matrix containing the sample, we found that the new signals gradually decreased and the original signals that had been present before irradiation recovered at 300 K (Figure 6B).

It should be noted here that the bis(4-pyridyl)carbene–Cu(hfac)<sub>2</sub> signals disappeared irreversibly at temperatures higher than 60 K.<sup>27d</sup> Thus, remarkable thermal stability of the DPy-1–Cu complex is noted.

#### UV–Vis Studies in a Matrix at Low Temperature.

Irradiation of a 1:1 mixture ( $1.5 \times 10^{-4}$  M) of 2,7-DPy-1-N<sub>2</sub> and Cu(hfac)<sub>2</sub> in 2-MTHF at 77 K gave rise to new absorption bands at the expense of the original absorption due to the complex. The new bands exhibited strong absorption at 363, 435, 497, and 600 nm (Figure 7Ab) and were significantly different from those observed for free carbene, 2,7-DPy-3<sup>1</sup> (363, 427, and 501 nm). When the matrix was gradually warmed,

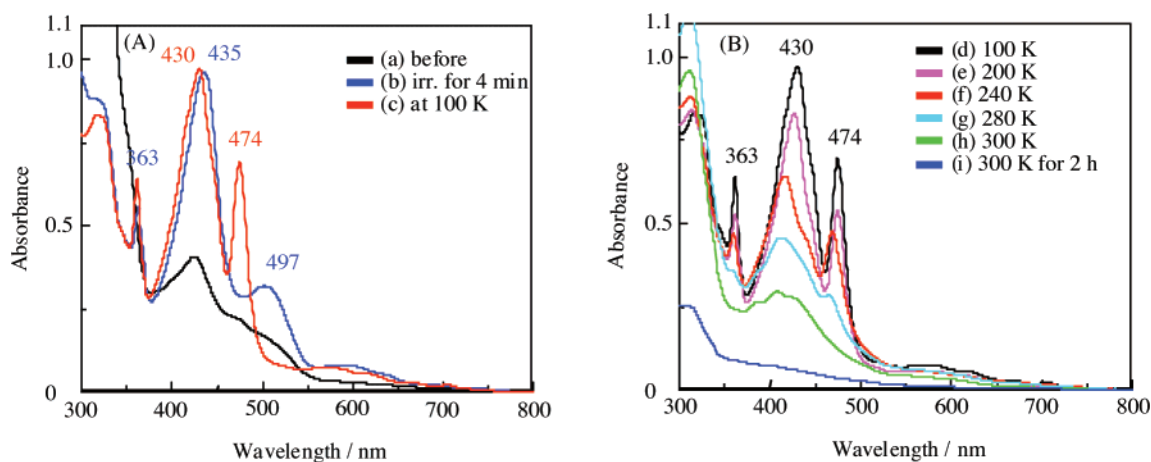

**Figure 7.** UV-vis spectra obtained by irradiation of 1:1 mixture ( $1.5 \times 10^{-4}$  M) of 2,7-DPy-1-N<sub>2</sub> and Cu(hfac)<sub>2</sub>. (A) (a) Spectra of 2,7-DPy-1-N<sub>2</sub> in 2-methyltetrahydrofuran at 77 K. (b) The same sample after irradiation (4 min,  $\lambda > 350$  nm). (c) The same sample after thawing to 100 K. (B) UV-vis spectral change measured upon warming the same sample from 100 to 300 K.

the bands at 497 nm became sharper and shifted to 474 nm, and the bands at 435 nm shifted to 430 nm at around 90 K (Figure 7Ac). These results can be compared with those observed for the free carbene, 2,7-DPy-<sup>3</sup>1, which exhibited similar but distinctly different absorption bands (at 363, 427, and 501 nm at 77 K and at 362, 420, 441, and 469 nm at 90 K).

Since the ESR signals most likely ascribable to the carbene-Cu complex are observed under identical conditions, we can assign the absorption spectrum to the carbene-metal complex. Similar slight red shift of the characteristic absorption due to carbene after complexation with Cu(hfac)<sub>2</sub> has been noted in bis(4-pyridyl)carbene-Cu(hfac)<sub>2</sub> systems.<sup>27</sup>

Upon further thawing, we saw that the band started to disappear slowly at around 200 K, and it disappeared completely after standing for about 2 h at 300 K (Figure 7B).

Similar irradiation of a 1:1 mixture ( $1.5 \times 10^{-4}$  M) of 2,2'-DPy-1-N<sub>2</sub> and Cu(hfac)<sub>2</sub> in 2-MTHF at 77 K gave rise to new absorption bands at 410, 487, 569, and 712 nm and was significantly different from those observed for the free carbene 2,2'-DPy-<sup>3</sup>1 (399, 420, 454, and 504 nm). Upon warming the matrix, we found that the bands at 410 and 487 nm became sharper and shifted to 409 and 472 nm, respectively, at around 90 K (Figure S6). These results can be compared with those for the free carbene, 2,2'-DPy-<sup>3</sup>1, which exhibited similar but distinctly different absorption bands (at 399, 420, 454, and 504 nm at 77 K and at 395 and 469 nm at 90 K). Since the ESR signals most likely ascribable to the carbene-Cu complex are observed under identical conditions, we can assign this absorption spectrum to the carbene-metal complex. The bands were observable up to 300 K.

**Superconducting Quantum Interference Device (SQUID) Measurements.** To determine the spin quantum numbers of the DPy-1-Cu complex, the magnetic properties before and after photolysis of the DPy-1-N<sub>2</sub>-copper complex in 2-MTHF solution were studied by using a SQUID magneto/susceptometer.

The 2-MTHF solution (50  $\mu$ L) of 2,7-DPy-1-N<sub>2</sub>-copper (1:1) complex ( $1.0 \times 10^{-3}$  M)<sup>28</sup> was placed inside the sample compartment of a SQUID magneto/susceptometer and was irradiated at 5–10 K with light ( $\lambda = 442$  nm) from a He/Cd laser passed through an optical fiber. The development of

magnetization ( $M/\text{emu}$ ) at 5 K in a constant field of 5 kOe with sample irradiation time was measured in situ and is shown in Figure 8A. As the irradiation time increased, the  $M$  values gradually increased, and they reached a plateau after 3 h. After the  $M$  values reached a plateau, the magnetization values after irradiation,  $M_a$ , were measured at 2.0 and 5.0 K in the field range of 0–50 kOe. The magnetization values of the sample before irradiation,  $M_b$ , were also measured under the same conditions (Figure 8B).

The magnetization generated by irradiation was then obtained by subtracting the values obtained before and after irradiation ( $M = M_a - M_b$ ). Thus, any magnetization from diamagnetic and paramagnetic impurities could be canceled out. The field dependence of magnetization for the complex after irradiation for 300 min, expressed by  $M$  versus  $H/T$  plots, is shown in Figure 9. The plots were analyzed in terms of the Brillouin function, as follows:<sup>1c, 27e, 29</sup>

$$M = M_a - M_b = M_{\text{complex}} - M_{\text{Cu}} \\ = Ng\mu_B [SB(\chi) - B(\chi')/2] \quad (2)$$

where  $N$  is the number of the molecules,  $\mu_B$  is the Bohr magneton,  $g$  is the Lande  $g$ -factor, and  $\chi = gS\mu_B H/(k_B T)$ ,  $\chi' = g'\mu_B H/(2k_B T)$ , where  $k_B$  is the Boltzmann constant and  $T$  is temperature. The  $g'$  value for the complex was 2.166, which was determined from EPR spectra obtained under similar conditions before irradiation.

The experimental data were fitted to the theoretical eq 2 to give spin quantum number  $S = 2.44 \pm 0.04$  and  $F$  (generation factor for carbene obtained from saturated magnetization) = 0.82 (dotted line in Figure 9).<sup>30</sup> Alternatively, the data were better analyzed by a two-component Brillouin function with  $S = 3.18 \pm 0.07$  ( $F = 0.66$ ) and  $S = 0.02 \pm 0.002$  ( $F = 0.23$ ) (solid curve in Figure 9). This may mean that defects due to

(28) The measurements were carried out at this low concentration not only to avoid intermolecular magnetic interaction of sample and but also to increase photolysis efficiency. The latter is especially important because we generate magnetic species (carbene-Cu complexes) in situ by photolysis of precursory diazo-Cu complexes: carbene-Cu complexes show rather strong absorption bands at 470–480 nm, and hence, at higher concentration, the bands due to carbene-Cu complexes grow and overlap with the bands due to the starting complex (see Figures 7 and S6).

(29) Carlin, R. L. *Magnetochemistry*; Springer-Verlag: Berlin, 1986.

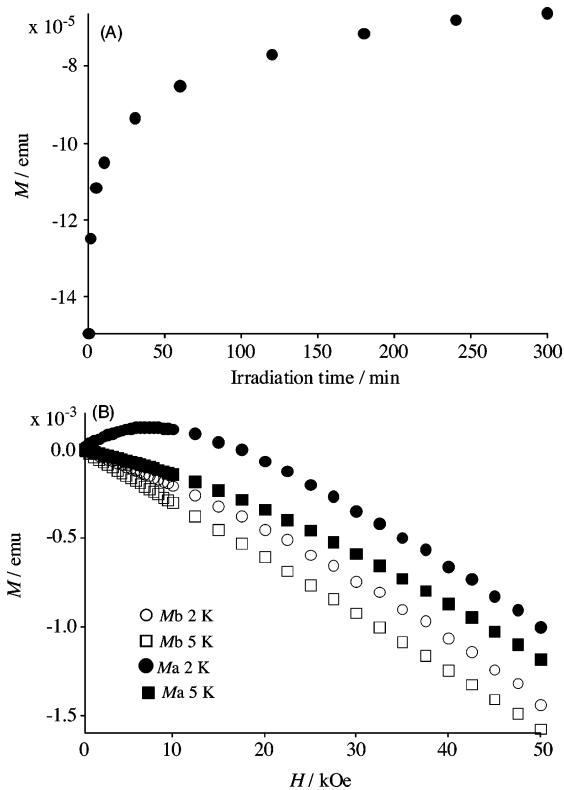

**Figure 8.** (A) Plot of magnetization ( $M$  in emu) as a function of irradiation time observed in the photolysis of 1:1 mixture ( $1.0 \times 10^{-3}$  M) of 2,7-DPy-1-N<sub>2</sub> and Cu(hfac)<sub>2</sub> in 2-methyltetrahydrofuran matrix measured at 5.0 K and 5 kOe. (B) Field dependence of the magnetization of the photoproduct from 1:1 mixture ( $1.0 \times 10^{-3}$  M) of 2,7-DPy-1-N<sub>2</sub> and Cu(hfac)<sub>2</sub> in 2-methyltetrahydrofuran matrix measured at 2.0 and 5.0 K.  $M_a$  and  $M_b$  refer to the magnetization value after and before irradiation, respectively.

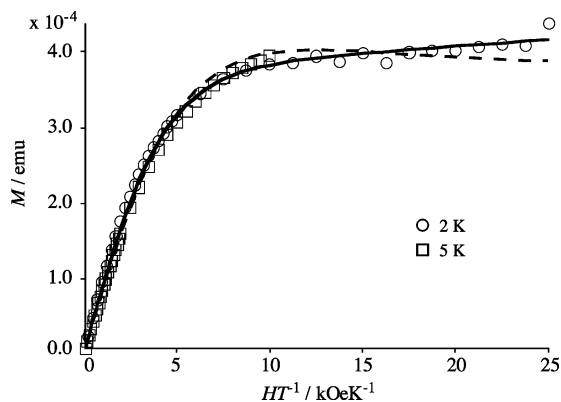

**Figure 9.** Plot of  $M$  vs  $H/T$  of the photoproduct from 1:1 mixture ( $1.0 \times 10^{-3}$  M) of 2,7-DPy-1-N<sub>2</sub> and Cu(hfac)<sub>2</sub> measured at 2.0 (○) and 5.0 (□) K in 2-methyltetrahydrofuran. Fitting data are shown as broken (one component) and solid (two components) lines.

incomplete photolysis produce mixtures of the spin systems in the chains. Since the magnetization data at two different

(30) (a) Variable parameters in eq 2 are  $N$  and  $S$  and all others are constants or experimental values. Thus,  $S$  values are estimated by best-fitting the curvature of  $M$  versus  $H/T$  plot from eq 2 while  $N$  (in Avogadro numbers) is obtained by fitting the best-fitted curves to the vertical axis.  $F$  values are then obtained from sample concentration and quantity. (b)  $M$  values in Figures 9 and 12 were obtained from  $M_a - M_b$ , where  $M_a$  and  $M_b$  refer to the magnetization value after and before irradiation, respectively. This means that  $M_b$  is mostly magnetization due to copper ion ( $S = 1/2$ ) in diazo-Cu complexes.  $M_a$  values will saturate more easily than  $M_b$  as a function of  $H$  since  $M_a$  values are larger than  $M_b$  values. Thus,  $M$  ( $= M_a - M_b$ ) decreases at higher field.

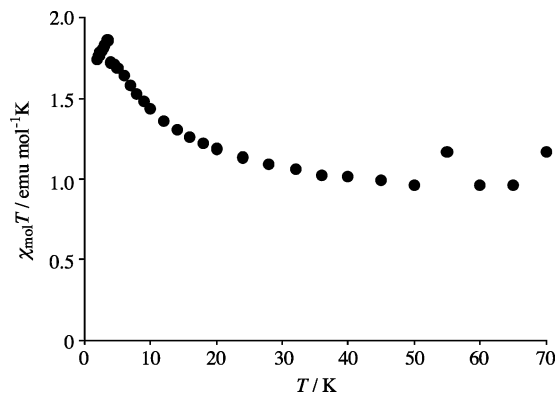

**Figure 10.** Temperature dependence of the observed  $\chi_{\text{mol}}T$  for the photoproduct from 1:1 mixture ( $1.0 \times 10^{-3}$  M) of 2,7-DPy-1-N<sub>2</sub> and Cu(hfac)<sub>2</sub> obtained at a field of 5 kOe.

temperatures were fitted to the same Brillouin function, the sample is considered to be free from ferro- or antiferromagnetic intermolecular interactions, and the high-spin state is considered to be a ground state.

The temperature dependence of the molar paramagnetic susceptibility before and after irradiation ( $\chi_{\text{molb}}$  and  $\chi_{\text{mola}}$ , respectively) in the range of 2–70 K was measured at a constant field of 5 kOe.  $\chi_{\text{mol}}$  ( $= \chi_{\text{mola}} - \chi_{\text{molb}}$ ) $T$  versus  $T$  plots are shown in Figure 10. The value of  $\chi_{\text{mol}}T$  increased with a decreasing temperature from 70 to 4 K. This indicates that  $J/k$  is small but positive, suggesting the presence of intramolecular ferromagnetic interaction.

The data obtained for photoproducts from similar irradiation of the 2-MTHF solution of the 1:1 2,2'-DPy-1-N<sub>2</sub>-copper complex (1.0 mM) were also analyzed by the Brillouin function (Figures 11 and 12). The experimental data ( $M$  versus  $H/T$ ) for the 2,2'-DPy-1-N<sub>2</sub>-copper complex after irradiation were analyzed in terms of eq 2 with the fitted curve giving  $S = 2.12 \pm 0.03$  and  $F = 0.41$  (Figure 12).<sup>30</sup> Alternatively, the data were better analyzed by the two-component Brillouin function that produced  $S = 2.70 \pm 0.13$  ( $F = 0.33$ ) and  $S = 0.49 \pm 0.24$  ( $F = 0.11$ ) (solid curve in Figure 12).

$\chi_{\text{mol}}$  ( $= \chi_{\text{mola}} - \chi_{\text{molb}}$ ) $T$  versus  $T$  plots (Figure 13) showed that the value of  $\chi_{\text{mol}}T$  increased with decreasing temperature from 70 to 4 K, again suggesting the presence of intramolecular ferromagnetic interaction.

It should be noted that the  $S$  and  $F$  values observed for the photoproduct of the 1:1 2,2'-DPy-1-N<sub>2</sub>-copper complex are notably smaller than those for that of the 1:1 2,7-DPy-1-N<sub>2</sub>-copper complex. Incomplete photolysis of diazo groups is often pointed out as a reason for rather small  $S$  and  $F$  values. However, almost complete photolysis of the sample was confirmed by taking the difference in absorption at 2040 cm<sup>-1</sup> due to the diazo moieties before and after SQUID measurements. It may be that there is a defect in the ligation of pyridine groups in the 2,2'-DPy-1-N<sub>2</sub>-copper complex. This is in accord with the observation that, in the ESR experiments on the photoproduct of the 2,2'-DPy-1-N<sub>2</sub>-copper complex, the signals due to free copper ions did not disappear completely. If there are partially uncoordinated copper ions in the complex, the magnetic contribution of the uncoordinated copper ions will be deleted in the equation  $M_{\text{complex}} - M_{\text{Cu}}$ , and this will result in small  $S$  and  $F$  values.



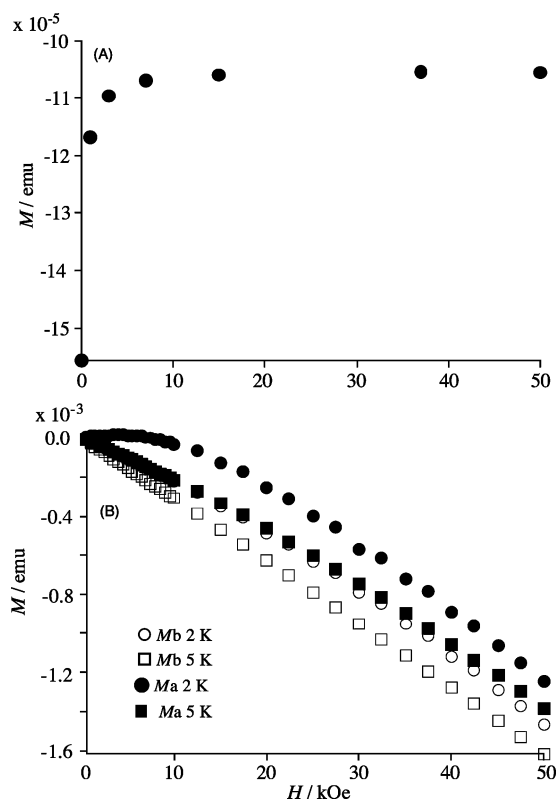

**Figure 11.** (A) Plot of magnetization ( $M$  in emu) as a function of irradiation time observed in the photolysis of 1:1 mixture ( $1.0 \times 10^{-3}$  M) of 2,2'-DPy-1-N<sub>2</sub> and Cu(hfac)<sub>2</sub> in 2-methyltetrahydrofuran matrix measured at 5.0 K and 5 kOe. (B) Field dependence of the magnetization of the photoproduct from 1:1 mixture ( $1.0 \times 10^{-3}$  M) of 2,2'-DPy-1-N<sub>2</sub> and Cu(hfac) in 2-methyltetrahydrofuran matrix measured at 2.0 and 5.0 K.  $M_a$  and  $M_b$  refer to the magnetization value after and before irradiation, respectively.

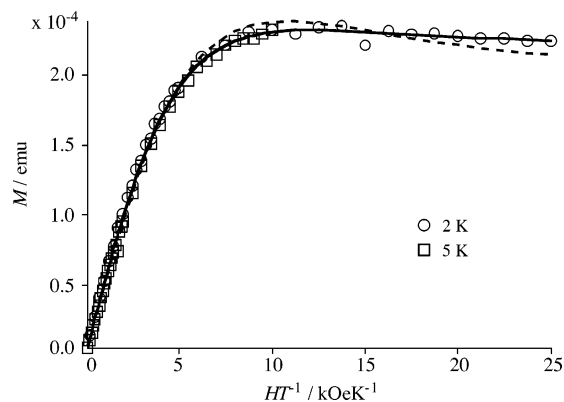

**Figure 12.** Plot of  $M$  vs  $H/T$  of the photoproduct from 1:1 mixture ( $1.0 \times 10^{-3}$  M) of 2,2'-DPy-1-N<sub>2</sub> and Cu(hfac)<sub>2</sub> measured at 2.0 (○) and 5.0 (□) K in 2-methyltetrahydrofuran. Fitting data are shown as broken (one component) and solid (two components) lines.

## Conclusion

The present results demonstrate that high-spin species are generated in the photoproduct of a copper ion complex with sterically congested diaryldiazomethanes having a 4-pyridyl group, as a result of ferromagnetic interaction between the 3d spin of metal ions and the 2p spins of triplet carbene through the pyridyl group located remote from the carbene center. The complexed carbene showed remarkable stability, surviving up to 300 K in 2-MTHF, while the analogous copper ion complex with an unprotected pyridylcarbene decays at temperatures

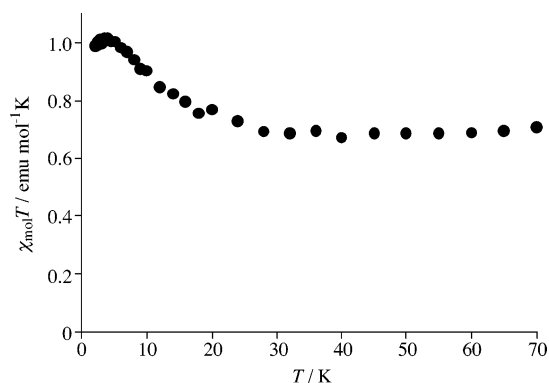

**Figure 13.** Temperature dependence of the observed  $\chi_{\text{mol}}T$  for the photoproduct from 1:1 mixture ( $1.0 \times 10^{-3}$  M) of 2,2'-DPy-1-N<sub>2</sub> and Cu(hfac)<sub>2</sub> obtained at a field of 5 kOe.

higher than 60 K. These observations suggest that it is potentially possible to prepare a persistent high-spin polycarbene by extending this method.

It should be noted that the spin quantum number obtained by Brillouin function analysis of the field dependence of magnetization is not very high. The apparent spin quantum number of the ferromagnetic chains consisting of a 1:1 complex between bis(4-pyridylcarbene)(DPy) and copper ions amounts to  $S = 33.6$ . This indicates that the ferromagnetic coupling in the chain is over 23.<sup>27a</sup> Since this measurement was made in the crystal state where the chain is expected to be held rather tightly, it may not be appropriate to directly compare the data. This value actually drops down to 6.4 when it is measured in a frozen solution of 2-MTHF, where the chain may be more flexible.<sup>27b</sup> Thus, part of the reason for the rather low  $S$  value is ascribable to the condition of the sample.

The spin quantum number of the 1:1 complex between DPy-1 and copper ions is, however, still significantly smaller than that of the 1:1 complex between bis(4-pyridylcarbene) and copper ions obtained under identical conditions.

Several factors affect the type and strength of spin coupling and, hence, the overall magnetic properties of polyradicals.<sup>1</sup> Among them, the connectivity in the present system is carefully designed so that the spins on the triplet carbene centers are transmitted effectively to the pyridine ligand and then on to the pyridine nitrogen, which then interacts ferromagnetically with the orbitals occupied by the unpaired d electrons of the copper ions (vide supra). The chemical defects, resulting from failure to generate a triplet carbene in the interior of the chain of the Cu-carbene and/or destruction of the carbene centers by reactions, may be part of the reason for the smaller  $S$  values in the DPy-1-Cu complex. However, similar  $S$  values observed for the 2,7-DPy-1-Cu complex, in which this chemical defect can be avoided, suggest that this is not the main factor. Intermolecular magnetic interactions sometimes complicate the study of spin coupling in poly-radicals<sup>3</sup> and -carbenes.<sup>6,7</sup> Since the magnetization data at two different temperatures were fitted to the same Brillouin function, the sample is considered to be free from ferro- or antiferromagnetic intermolecular interactions. The temperature dependence of the molar paramagnetic susceptibility also suggests the presence of intramolecular ferromagnetic interaction.

Delocalization of spin is also an important factor. It has been shown that spin coupling is weaker for  $\pi$ -conjugated dinitroxides than their carbon counterparts because spin density is delocalized

on the nitroxide moiety in  $\pi$ -conjugated nitroxides.<sup>1c,5</sup> Significantly small  $D$  values observed for dianthrylcarbenes suggest that the unpaired electrons are extensively delocalized into dianthryl rings. Although the spin density builds up at the 2 (and 2') and 7 (and 7') positions, where ligands are connected, the spins are significantly dispersed in the ring carbons, and hence, the net spin densities on 2 (and 2') and 7 (and 7') carbon atoms in triplet dianthrylcarbenes are actually not large. Then the density is further diminished in conduit of the pyridine ring until the spins are transmitted onto the pyridine nitrogen atoms, due to partial localization on the ortho carbon atoms and possible twisting of the pyridyl rings from the plane of the anthryl ring.

These factors can explain the rather small  $S$  value observed for the present system compared to that of the 1:1 complex between bis(4-pyridyl)carbene and copper ions.<sup>27</sup> In this respect, triplet bis(9-acridyl)carbene, in which nitrogen atoms are incorporated at the 10-position of the anthryl ring, is a more promising candidate for realizing persistent high-spin species consisting of 2p spins of carbene and 3d spins of metal ions.

An advantage of the present approach is its easiness to increase the dimension of the spin network. Koga and co-workers have increased the dimension of the spin networks from one- to two- and three-dimensional structures by using highly branched base ligand containing diazo units. For instance, a high-spin carbene–copper ion complex with an  $S$  value higher than 1000 was obtained by photolysis of 3:2 complex of Cu-(hfac)<sub>2</sub> and 1,3,5-benzotriyltris(4-pyridyldiazomethane).<sup>27b</sup> The preparation of desired precursory aromatic  $\pi$ -net works having poly(4-pyridyldiazobenzyl) unit will be achieved by extending the present method.

Attempts to realize a stable high-spin organic species have been made mostly by using a thermodynamically stable radical such as triarylmethyl and aminoxyl radicals. For instance, Rajca and co-workers have made great efforts to construct stable high-spin organic species comprising triarylmethyls and realized a very high-spin species with values of  $S \approx 5000$ .<sup>4b</sup> Iwamura and co-workers have used  $\pi$ -conjugated olygo(aminoxyl) radicals as bridging ligands and coordinatively unsaturated paramagnetic 3d transition metal ions as connectors and have constructed two- and three-dimensional networks in which both the organic 2p and metallic 3d spins have been ordered in macroscopic scales.<sup>5d</sup>

Then one may ask why one needs to use persistent triplet carbene as a unit to construct persistent high-spin species. Moreover, the values of  $S$  for DPy-1–Cu complexes in the present study are smaller than that of “parent” system, that is, the ferromagnetic chains consisting of a 1:1 complex between bis(4-pyridylcarbene)(DPy) and copper ions, which may mean that one needs not use persistent triplet carbene. However, we should emphasize here that the effectiveness of spin source to construct high-spin species should be compared in a system in which a spin unit is incorporated into essentially the same  $\pi$ -net works. In this regards, it is very intriguing to note here that poly(phenyl)acetylenes having persistent triplet diarylcarbene units are found to have  $S = 9$  spin states,<sup>13g</sup> while similar acetylenes having thermodynamically stabilized radicals have been shown to have a spin multiplicity of only  $1/2$ .<sup>31</sup>

The very high-spin organic species comprising of triarylmethyls is achieved<sup>4</sup> by connecting  $S = 3$  calix[4]arene macrocycles with  $S = 1/2$  bis(biphenylene)methyl groups, where out-of-plane twistings, reverting the sign of exchange coupling from ferromagnetic to antiferromagnetic, and chemical defect in the interior, interrupting the exchange pathway, are carefully eliminated, and the ferrimagnetic coupling scheme, that is, antiferromagnetic coupling of unequal spins leading to a large net spin magnetic moment, is applied. Approach along this line using persistent triplet carbenes may also be possible by taking advantage of the stability of our diazo compounds.

## Experimental Section

**General Methods.** <sup>1</sup>H and <sup>13</sup>C NMR spectra were recorded on JEOL JNM-AC300FT/NMR spectrometer in CDCl<sub>3</sub> with Me<sub>4</sub>Si as an internal reference. IR spectra were measured on a JASCO-Herschel FT/IR-410H spectrometer, and UV–vis spectra were recorded on a JASCO CT-560 spectrophotometer. The mass spectra were recorded on a JEOL JMS-600H mass spectrometer. Gel permeation chromatography (GPC) was carried out on a JASCO, model HLC-01 instrument using UV-1570 as a detector. The GPC column was a Shodex H-2001. Thin-layer chromatography was carried out on a Merck Kieselgel 60 PF<sub>254</sub>. Column chromatography was performed on silica gel 60N (KANTO chemical) for column chromatography or ICN for dry column chromatography.

Unless otherwise noted, all the reagents employed in this study are commercial products and used after standard purification. Tetrahydrofuran, ethyl ether, toluene, and dioxane were purified by distillation from sodium/benzophenone, and dichloromethane, carbon tetrachloride, and triethylamine were from calcium hydride.

**Preparation of [10-(4-*tert*-Butyl-2,6-dimethylphenyl)-9-anthryl]-[10-(4-*tert*-butyl-2,6-dimethylphenyl)-2,7-di(4-pyridyl)-9-anthryl]-diazomethane (2,7-DPy-1–N<sub>2</sub>).** To a solution of 4-*tert*-butyl-2,6-dimethylbromobenzene<sup>32</sup> (2.7 g, 11.3 mmol) in anhydrous diethyl ether (40 mL) was added 1.4 M *tert*-butyllithium in *n*-pentane (17.0 mL, 24.0 mmol) at –78 °C under nitrogen atmosphere. The mixture was stirred for 1 h at –78 °C and allowed to warm to room temperature. To this mixture, a solution of 3,6-dibromo-9,10-dihydro-9-oxoanthracene<sup>33</sup> (2.0 g, 5.6 mmol) in anhydrous toluene (100 mL) was added, and the mixture was refluxed overnight. The mixture was allowed to cool to room temperature, and a saturated ammonium chloride aqueous solution was added carefully to it. The reaction mixture was extracted with diethyl ether, and the organic layer was washed with water and dried over anhydrous sodium sulfate. A brown solid obtained after concentration of the solution was chromatographed on a silica gel column eluted with *n*-hexane to afford **2,7-dibromo-10-(4-*tert*-butyl-2,6-dimethylphenyl)anthracene** as a pale-yellow solid in 34% yield (0.9 g): mp 215 °C. <sup>1</sup>H NMR (CDCl<sub>3</sub>):  $\delta$  1.43 (s, 9H), 1.70 (s, 6H), 7.24 (s, 2H), 7.31 (d,  $J = 9.4$  Hz, 2H), 7.36 (dd,  $J = 1.7, 9.2$  Hz, 2H), 8.18 (d,  $J = 1.7$  Hz, 2H), 8.23 (s, 1H). <sup>13</sup>C NMR (CDCl<sub>3</sub>):  $\delta$  20.3, 31.5, 34.5, 120.3, 124.1, 124.6, 128.1, 128.2, 129.4, 130.1, 132.9, 133.2, 136.8, 137.4, 150.9. EIMS  $m/z$  (relative intensity): 498 (M + 4, 54.0), 496 (M + 2, 100), 494 (M<sup>+</sup>, 52.8); HRMS calcd for C<sub>26</sub>H<sub>24</sub>Br<sub>2</sub>, 494.0244; found  $m/z$ , 494.0230.

To a cooled and stirred solution of 2,7-dibromo-10-(4-*tert*-butyl-2,6-dimethylphenyl)anthracene (900 mg, 1.85 mmol) in carbon tetrachloride (10 mL), a carbon tetrachloride solution (2 mL) of bromine (0.10 mL, 2.04 mmol) was added dropwise at 0 °C, and the mixture was stirred at room temperature overnight. To this mixture, an aqueous solution of 10% sodium hydroxide was added carefully. The reaction mixture was extracted with carbon tetrachloride, and the organic layer

(31) (a) Miura, Y.; Matsumoto, M.; Ushitani, Y.; Taki, Y.; Takui, T.; Itoh, K. *Macromolecules* **1993**, *26*, 6673. (b) Nishide, H.; Kaneko, T.; Igarashi, M.; Tsuchida, E.; Yoshioka, N.; Lahti, P. *Macromolecules* **1994**, *27*, 3082. (c) Lahti, P. M.; Inceli, A. L.; Rossitto, F. C. *J. Polym. Sci., Part A: Polym. Chem.* **1997**, *35*, 2167.

(32) Ogata, Y.; Kosugi, Y.; Nate, N. *Tetrahedron* **1971**, *27*, 2705.

(33) Biehl, R.; Hinrichs, K.; Lubitz, W.; Mennenga, U.; Roth, K. *J. Am. Chem. Soc.* **1977**, *99*, 4278.

was washed with water and dried over anhydrous sodium sulfate. After removal of the solvent, **2,7,9-tribromo-10-(4-*tert*-butyl-2,6-dimethylphenyl)anthracene** (1.0 g, 94%) was obtained as a yellow solid: mp 286 °C. <sup>1</sup>H NMR (CDCl<sub>3</sub>): δ 1.43 (s, 9H), 1.69 (s, 6H), 7.24 (s, 2H), 7.33 (dd, *J* = 0.6, 9.2 Hz, 2H), 7.41 (dd, *J* = 1.8, 9.2 Hz, 2H), 8.77 (dd, *J* = 0.5, 1.9 Hz, 2H). <sup>13</sup>C NMR (CDCl<sub>3</sub>): δ 20.3, 31.5, 34.5, 119.5, 122.8, 124.8, 128.5, 129.0, 129.8, 130.0, 131.8, 132.8, 136.7, 137.9, 151.3. EIMS *m/z* (relative intensity): 576 (M + 4, 62.1), 574 (M + 2, 63.0), 572 (M<sup>+</sup>, 22.7); HRMS calcd for C<sub>26</sub>H<sub>23</sub>Br<sub>3</sub>, 571.9349; found *m/z*, 571.9364.

To a solution of the bromide (2.0 g, 4.79 mmol) in anhydrous diethyl ether (10 mL) was added 2.6 M *n*-butyllithium in *n*-hexane (2.2 mL, 5.75 mmol) at 0 °C under nitrogen atmosphere, and the mixture was stirred for 2 h at 0 °C. Absolute DMF (1.12 mL, 14.37 mmol) was added to the lithiated mixture at 0 °C, and the mixture was refluxed overnight. The mixture was allowed to cool to room temperature, and a saturated ammonium chloride aqueous solution was added carefully. Insoluble material was filtered and washed with water to give a crude aldehyde (1.4 g). The filtrate was extracted with diethyl ether, and the organic layer was washed with water, dried over anhydrous sodium sulfate, and evaporated to leave a crude product (0.7 g). The combined crude product was chromatographed on a silica gel column eluted with *n*-hexane/dichloromethane (1:1). **10-(4-*tert*-Butyl-2,6-dimethylphenyl)-anthracene-9-carbaldehyde** was obtained as a yellow solid in 57% yield (1.0 g): mp 218 °C. <sup>1</sup>H NMR (CDCl<sub>3</sub>): δ 1.44 (s, 9H), 1.72 (s, 6H), 7.24 (s, 2H), 7.38–7.43 (m, 2H), 7.56 (d, *J* = 8.8 Hz, 2H), 7.64–7.69 (m, 2H), 9.04 (d, *J* = 9.0 Hz, 2H), 11.60 (s, 1H). <sup>13</sup>C NMR (CDCl<sub>3</sub>): δ 20.3, 31.5, 34.5, 123.7, 124.59, 124.60, 125.9, 127.1, 128.8, 129.4, 131.9, 133.9, 136.3, 145.4, 151.0, 193.4. IR (KBr, cm<sup>-1</sup>): 3066w, 3044w, 2960s, 2915w, 2864m, 2765w, 1680vs(ν<sub>C=O</sub>), 1607vw, 1556m, 1483w, 1438m, 1406vw, 1362w, 1270m, 1230vw, 1190m, 1152w, 1048m, 1029vw, 945m, 900w, 876w, 799w, 758m, 753m, 734w, 662m, 642vw, 602w, 569vw. EIMS *m/z* (relative intensity) 366 (M<sup>+</sup>, 100), 351 (36.9); HRMS calcd for C<sub>27</sub>H<sub>26</sub>O, 366.1984; found *m/z*, 366.1986.

To a solution of 2,7,9-tribromo-10-(4-*tert*-butyl-2,6-dimethylphenyl)-anthracene (7.00 g, 12.2 mmol) in anhydrous diethyl ether (90 mL) was added 2.4 M *n*-butyllithium in *n*-hexane (6.0 mL, 14.6 mmol) at 0 °C under nitrogen atmosphere, and the mixture was stirred for 2 h at 0 °C. A solution of 10-(4-*tert*-butyl-2,6-dimethylphenyl)anthracene-9-carbaldehyde (4.46 g, 12.2 mmol) in anhydrous tetrahydrofuran (100 mL) was added to the lithiated mixture at 0 °C, and the mixture was heated overnight at 40 °C. The mixture was allowed to cool to room temperature, and a saturated ammonium chloride solution was added carefully. The reaction mixture was extracted with diethyl ether, and the organic layer was washed with water, dried over anhydrous sodium sulfate, and evaporated. The crude product **[10-(4-*tert*-butyl-2,6-dimethylphenyl)-9-anthryl][2,7-dibromo-10-(4-*tert*-butyl-2,6-dimethylphenyl)-anthryl]methanol** (11.9 g, quantitatively) was obtained as a brown solid: mp 208.6–211.4 °C. <sup>1</sup>H NMR (CDCl<sub>3</sub>): δ 1.43 (s, 9H), 1.45 (s, 9H), 1.72 (s, 6H), 1.77 (s, 6H), 3.01 (d, *J* = 2.8 Hz, 1H), 7.24 (s, 4H), 7.25–7.31 (m, 6H), 7.33 (d, *J* = 9.2 Hz, 2H), 7.53–7.57 (m, 2H), 8.51–8.54 (m, 3H), 8.85 (d, *J* = 1.7 Hz, 2H). <sup>13</sup>C NMR (CDCl<sub>3</sub>): δ 20.2, 20.4, 31.5, 31.6, 34.49, 34.51, 73.0, 121.4, 124.5, 124.7, 124.8, 125.1, 126.3, 127.3, 127.8, 128.4, 128.80, 128.85, 130.0, 131.5, 132.0, 133.68, 133.73, 134.7, 136.8, 136.9, 138.8, 139.1, 150.5, 151.0, 1501.0. MS (MALDI-TOF) calcd for C<sub>53</sub>H<sub>48</sub>Br<sub>2</sub>O (M – H<sup>+</sup>), 859.2145; found *m/z*, 859.2281.

Into a solution of the methanol (11.76 g, 12.17 mmol) in anhydrous benzene (100 mL) cooled to 0 °C, a hydrogen chloride gas generated by adding hydrochloric acid (66 mL) to sulfuric acid (99 mL) was bubbled for 1 h, and the mixture was stirred for 1 h at 0 °C. Removal of the solvent afforded **[10-(4-*tert*-butyl-2,6-dimethylphenyl)-9-anthryl][2,7-dibromo-10-(4-*tert*-butyl-2,6-dimethylphenyl)-9-anthryl]-chloromethane** (11.86 g, quantitatively) as a brown viscous liquid. This was used without further purification since the chloride was found to be rather unstable.

A solution of the chloromethane (11.86 g, 12.17 mmol) in anhydrous 1,4-dioxane (100 mL) was added to a molten mixture of silver tetrafluoroborate (3.53 g, 18.26 mmol) and urethane (21.68 g, 343.4 mmol) at 60 °C. After addition was completed, the mixture was refluxed overnight. After cooling, silver chloride was removed from the reaction mixture by filtration and washed with chloroform. The filtrate was washed with water, and the organic layer was dried over anhydrous sodium sulfate and evaporated. The crude product was chromatographed on a silica gel column eluted with *n*-hexane/dichloromethane (3:2). **Ethyl [10-(4-*tert*-butyl-2,6-dimethylphenyl)-9-anthryl][2,7-dibromo-10-(4-*tert*-butyl-2,6-dimethylphenyl)-9-anthryl]methylcarbamate** was obtained as a yellow solid in 39% yield (4.56 g): mp 203.2–206.8 °C. <sup>1</sup>H NMR (CDCl<sub>3</sub>): δ 1.33 (t, *J* = 7.0 Hz, 3H), 1.42 (s, 9H), 1.44 (s, 9H), 1.69 (s, 6H), 1.74 (s, 6H), 4.16–4.42 (m, 2H), 5.97 (d, *J* = 7.2 Hz, 1H), 7.22–7.33 (m, 12H), 7.53 (d, *J* = 9.2 Hz, 2H), 8.41 (d, *J* = 8.3 Hz, 2H), 8.54 (d, *J* = 7.3 Hz, 1H), 8.77 (s, 2H). <sup>13</sup>C NMR (CDCl<sub>3</sub>): δ 14.8, 20.2, 20.4, 31.48, 31.55, 34.47, 34.50, 54.6, 61.7, 121.5, 123.9, 124.4, 124.6, 125.0, 126.54, 126.57, 126.9, 127.4, 128.3, 128.3, 128.5, 129.1, 129.7, 130.0, 131.3, 131.4, 134.6, 136.8, 136.9, 138.6, 150.5, 150.9, 155.4. MS (MALDI-TOF) calcd for C<sub>56</sub>H<sub>53</sub>Br<sub>2</sub>NO<sub>2</sub> (M – H<sup>+</sup>), 930.2516; found *m/z*, 930.2586.

The replacement reaction of bromine with iodine was carried out according to the methods reported by Buchwald.<sup>34</sup> To a mixture of ethyl [10-(4-*tert*-butyl-2,6-dimethylphenyl)-9-anthryl][2,7-dibromo-10-(4-*tert*-butyl-2,6-dimethylphenyl)-9-anthryl]methylcarbamate (451 mg, 0.41 mmol), sodium iodide (1.08 g, 7.25 mmol), and copper iodide (I) (73 mg, 0.38 mmol), anhydrous 1,4-dioxane (20 mL) was added under argon atmosphere, and this mixture was stirred for 5 min. To the mixture, *N,N'*-dimethylethylenediamine (20 mL, 0.14 mmol) was added, and the mixture was refluxed for 2 days. After cooling, sodium bromide was removed from the reaction mixture by filtration and washed with chloroform, and the filtrate was evaporated. **Ethyl [10-(4-*tert*-Butyl-2,6-dimethylphenyl)-9-anthryl][2,7-diiodo-10-(4-*tert*-butyl-2,6-dimethylphenyl)-9-anthryl]methylcarbamate** was obtained as a brown solid in 91% yield (450 mg): mp 181.2–183.0 °C. <sup>1</sup>H NMR (CDCl<sub>3</sub>): δ 1.34 (t, *J* = 7.3 Hz, 3H), 1.41 (s, 9H), 1.43 (s, 9H), 1.68 (s, 6H), 1.76 (s, 6H), 4.14–4.42 (m, 2H), 5.97 (d, *J* = 7.2 Hz, 1H), 7.14–7.43 (m, 12H), 7.53 (d, *J* = 8.5 Hz, 2H), 8.43 (d, *J* = 8.6 Hz, 2H), 8.54 (d, *J* = 7.2 Hz, 1H), 9.06 (s, 2H). <sup>13</sup>C NMR (CDCl<sub>3</sub>): δ 14.9, 20.2, 20.6, 31.5, 31.6, 34.47, 34.49, 54.6, 61.7, 93.8, 123.8, 124.4, 124.6, 125.0, 126.6, 126.7, 127.5, 128.6, 128.7, 129.7, 129.9, 131.5, 133.3, 133.4, 133.5, 134.0, 134.6, 136.8, 137.0, 138.6, 150.5, 150.9, 155.4. MS (MALDI-TOF) calcd for C<sub>56</sub>H<sub>54</sub>I<sub>2</sub>NO<sub>2</sub>, 1026.2239; found *m/z*, 1026.3464.

A dinitrogen tetraoxide (0.9 g, 9.0 mmol) was bubbled into anhydrous carbon tetrachloride (10 mL) at –20 °C. To this solution, sodium acetate (1.6 g, 18.0 mmol) and a solution of the carbamate (1.00 g, 1.00 mmol) in anhydrous carbon tetrachloride (25 mL) were added at –20 °C, and the mixture was stirred for 2 h at 0 °C. The reaction mixture was poured into crushed ice and extracted with carbon tetrachloride. The organic layer was washed with aqueous sodium hydrogen carbonate and water and dried over anhydrous sodium sulfate. After evaporation of the solvent, a residual solid was dissolved in anhydrous tetrahydrofuran (30 mL) under nitrogen atmosphere and cooled to –20 °C. Potassium *t*-butoxide (155 mg, 1.47 mmol) was added to the mixture, and the mixture was stirred overnight at room temperature. The reaction mixture was extracted with diethyl ether, and the organic layer was washed with water and dried over anhydrous sodium sulfate. After evaporation of the solvent, the residue was purified by GPC (16 cycles, chloroform as eluent) to give **[10-(4-*tert*-butyl-2,6-dimethylphenyl)-9-anthryl][2,7-diiodo-10-(4-*tert*-butyl-2,6-dimethylphenyl)-9-anthryl]diazomethane** (204 mg, 21%) as an orange solid. <sup>1</sup>H NMR (CDCl<sub>3</sub>): δ 1.43 (s, 9H), 1.45 (s, 9H), 1.74 (s, 6H), 1.82 (s, 6H), 7.24 (s, 2H), 7.27 (s, 2H), 7.34–7.51 (m, 10H), 7.60 (d, *J* = 8.6 Hz, 2H), 8.29 (d, *J* = 8.8 Hz, 2H), 8.75 (d, *J* = 1.5 Hz, 2H).

(34) Klapars, A.; Buchwald, S. *J. Am. Chem. Soc.* **2002**, *124*, 14844.



$^{13}\text{C}$  NMR ( $\text{CDCl}_3$ ):  $\delta$  20.3, 20.5, 31.5, 31.6, 34.5, 55.5, 123.1, 124.0, 124.5, 124.7, 125.1, 125.6, 127.0, 127.4, 128.8, 129.1, 130.4, 130.47, 130.50, 131.4, 133.2, 134.2, 133.4, 134.8, 136.9, 137.0, 138.5, 138.9, 150.6, 141.1. IR ( $\text{NaCl}$ ,  $\text{cm}^{-1}$ ): 3063vw, 3018w, 2965s, 2925m, 2868w, 2041vs( $\nu_{\text{C}=\text{N}_2}$ ), 1711w, 1605w, 1589w, 1481w, 1458w, 1432m, 1379w, 1326m, 1215s, 1192vw, 945m, 903vw, 870w, 825w, 821w, 681w, 670s, 651w, 624w, 609w.

To a mixture of the diiodo-diazomethane (204 mg, 0.21 mmol) in anhydrous dioxane (2 mL), 2-(4-pyridyl)-4,4,5,5-tetramethyl-1,3-dioxaborolane (346 mg, 1.68 mmol), [1,1'-bis(diphenylphosphino)ferrocene]-palladium dichloride dichloromethane complex:  $\text{PdCl}_2(\text{dppf})_2\cdot\text{CH}_2\text{Cl}_2$  (50 mg, 0.05 mol), and potassium phosphate (366 mg, 1.68 mmol) were added under Ar atmosphere, and the mixture was stirred at 35 °C for 2 days. The mixture was then filtered, and the filtrate was evaporated under reduced pressure. The resulting brown semisolid was purified by GPC (eight cycles, chloroform as eluent) and TLC ( $\text{Et}_2\text{O}-n$ -hexane = 1:1) to give dipyrityldialted diazomethane **2,7-DPy-1-N<sub>2</sub>** (16 mg, 4%) as an orange solid.  $^1\text{H}$  NMR ( $\text{CDCl}_3$ ):  $\delta$  1.44 (s, 9H), 1.47 (s, 9H), 1.64 (s, 6H), 1.84 (s, 6H), 7.20 (brs, 4H), 7.24 (s, 2H), 7.30 (s, 2H), 7.35–7.46 (m, 4H), 7.60–7.64 (m, 4H), 7.69 (d,  $J$  = 8.3 Hz, 2H), 8.46 (brs, 4H), 8.75 (s, 2H).  $^{13}\text{C}$  NMR ( $\text{CDCl}_3$ ):  $\delta$  20.1, 20.4, 31.5, 34.5, 34.6, 55.9, 121.3, 124.3, 124.5, 124.6, 124.7, 124.9, 125.2, 125.7, 126.8, 127.3, 127.6, 128.8, 130.3, 130.5, 130.7, 130.8, 133.7, 134.1, 135.8, 136.7, 136.9, 137.9, 139.1, 147.4, 150.2, 150.8, 151.0. IR ( $\text{NaCl}$ ,  $\text{cm}^{-1}$ ) 2962s, 2924m, 2856w, 2037vs( $\nu_{\text{C}=\text{N}_2}$ ), 1594m, 1491w, 1477w, 1458w, 1449w, 1438w, 1407vw, 1379w, 1363w, 816vw, 752vw.

**Preparation of Bis[10-(4-tert-butyl-2,6-dimethylphenyl)-2-(4-pyridyl)-9-anthryl]diazomethane (2,2'-DPy-1-N<sub>2</sub>).** To a Grignard reagent prepared from 1,3-dibromobenzene (13 mL, 106 mmol), magnesium (2.7 g, 106 mmol), and iodine (catalytic amount) in absolute diethyl ether (50 mL) was added a solution of 2-formylbenzoic acid (6.6 g, 44 mmol) in absolute tetrahydrofuran (50 mL) dropwise with vigorous stirring. The mixture was refluxed overnight. After being cooled to room temperature, 5% hydrochloric acid (66 mL) was added to the reaction mixture, and the mixture was washed with saturated sodium hydrogen carbonate aqueous solution. To the aqueous solution was added concentrated hydrochloric acid until it became acidic. The precipitation formed was collected by filtration and recrystallized from ethanol. **3-(4-Bromophenyl)phthalide** was obtained as a yellow solid in 84% yield (10 g); mp 135.5–137.0 °C.  $^1\text{H}$  NMR ( $\text{CDCl}_3$ ):  $\delta$  6.35 (s, 1H), 7.24 (t,  $J$  = 2.0 Hz, 1H), 7.29 (s, 1H), 7.34 (d,  $J$  = 7.4 Hz, 1H), 7.42 (s, 1H), 7.50 (td,  $J$  = 1.9, 7.0 Hz, 1H), 7.57 (t,  $J$  = 7.1 Hz, 1H), 7.67 (dt,  $J$  = 1.3, 7.5 Hz, 1H), 7.97 (d,  $J$  = 7.7 Hz, 1H).  $^{13}\text{C}$  NMR ( $\text{CDCl}_3$ ):  $\delta$  81.6, 127.7, 123.0, 125.4, 125.5, 125.9, 129.6, 129.9, 130.6, 132.4, 134.5, 138.7, 149.0, 170.1; MS  $m/z$  (relative intensity): 290 ( $M + 2$ , 34), 288 ( $M^+$ , 34), 209 (58), 105(100); HRMS calcd for  $\text{C}_{14}\text{H}_9\text{O}_2\text{Br}$ , 287.9785; found  $m/z$ , 287.9814.

A mixture of the phthalide (3.5 g, 12 mmol), iodine (2.1 g, 8.3 mmol), and red phosphorus (1.9 g, 62 mmol) in water (0.5 mL) propionic acid (20 mL) was heated and stirred for 10 min at 100 °C. Water (10 mL) was added to the cooled mixture, and the precipitate formed was filtered. The precipitate was dissolved into chloroform, and the mixture was filtered. The filtrate was dried over anhydrous sodium sulfate. After removal of the solvent, **2-(3-bromobenzyl)benzoic acid** was obtained as a pale orange solid (3.4 g, 99%); mp 120.1–121.9 °C.  $^1\text{H}$  NMR ( $\text{CDCl}_3$ ):  $\delta$  1.67 (s, 1H), 4.41 (s, 1H), 6.35 (s, 1H), 7.10 (d,  $J$  = 3.1 Hz, 1H), 7.15 (t,  $J$  = 7.2 Hz, 1H), 7.22 (d,  $J$  = 7.5 Hz, 1H), 7.30 (s, 1H), 7.31 (s, 1H), 7.35 (t,  $J$  = 7.4 Hz, 1H), 7.49 (t,  $J$  = 7.5 Hz, 1H), 8.06 (d,  $J$  = 7.9 Hz, 1H);  $^{13}\text{C}$  NMR ( $\text{CDCl}_3$ ):  $\delta$  39.3, 122.4, 126.7, 127.6, 128.26, 128.32, 129.1, 129.8, 131.8, 131.9, 133.2, 142.5, 143.1, 173.0; EIMS  $m/z$  (relative intensity): 292 ( $M + 2$ , 31), 290 ( $M^+$ , 33), 193 (100); HRMS calcd for  $\text{C}_{14}\text{H}_{11}\text{O}_2\text{Br}$ , 290.0020; found  $m/z$ , 289.9942.

To a concentrated sulfuric acid (67 mL) was added 2-(3-bromobenzyl)benzoic acid little by little at 0 °C with vigorous stirring. After being stirred for 45 min at 0 °C and for another 45 min at room

temperature, the mixture was added to water. The precipitate formed was filtered and recrystallized from ethanol to give **3-bromo-9,10-dihydro-9-oxoanthracene** as an ochreous color solid (6.6 g, 96%); mp 141.2–142.2 °C.  $^1\text{H}$  NMR ( $\text{CDCl}_3$ ):  $\delta$  4.34 (s, 2H), 7.47 (d,  $J$  = 7.2 Hz, 1H), 7.50 (t,  $J$  = 2.4 Hz, 1H), 7.58 (d,  $J$  = 7.5 Hz, 1H), 7.61 (dd,  $J$  = 4.0, 2.0 Hz, 1H), 7.65 (d,  $J$  = 2.0 Hz, 1H), 8.21 (d,  $J$  = 8.5 Hz, 1H), 8.36 (dd,  $J$  = 6.4, 1.7 Hz, 1H);  $^{13}\text{C}$  NMR ( $\text{CDCl}_3$ ):  $\delta$  31.9, 127.2, 127.5, 127.9, 128.4, 129.3, 130.5, 130.8, 131.2, 131.6, 133.0, 139.7, 142.0, 183.3; EIMS  $m/z$  (relative intensity): 274 ( $M + 2$ , 98), 272 ( $M^+$ , 100), 193 (90); HRMS calcd for  $\text{C}_{14}\text{H}_9\text{OBr}$ , 271.9824; found  $m/z$ , 271.9836.

To a solution of 4-tert-butyl-2,6-dimethylbromobenzene<sup>29</sup> (0.80 g, 3.3 mmol) in anhydrous diethyl ether (30 mL) was added 1.5 M tert-butyllithium in *n*-pentane (5.0 mL, 7.3 mmol) at –78 °C under nitrogen atmosphere. The mixture was stirred for 1 h at –78 °C and allowed to warm to room temperature. To this mixture, a solution of 3-bromo-9,10-dihydro-9-oxoanthracene (0.91 g, 3.3 mmol) in anhydrous toluene (50 mL) was added, and the mixture was refluxed overnight. The mixture was allowed to cool to room temperature, and a saturated ammonium chloride aqueous solution was added to it carefully. The reaction mixture was extracted with diethyl ether, and the organic layer was washed with water and dried over anhydrous sodium sulfate. A brown solid obtained after concentration of the solution was chromatographed on a silica gel column eluted with *n*-hexane. The eluted fraction was distilled by a short-path distillation apparatus at 100 °C/760 Pa to obtain **2-bromo-10-(4-tert-butyl-2,6-dimethylphenyl)anthracene** as a pale yellow solid in 35% yield (0.48 g); mp 185.3–187.0 °C.  $^1\text{H}$  NMR ( $\text{CDCl}_3$ ):  $\delta$  1.43 (s, 9H), 1.71 (s, 6H), 7.24 (s, 2H), 7.30–7.34 (m, H), 7.43–7.49 (m, 2H), 8.02 (d,  $J$  = 8.5 Hz, 1H), 8.20 (s, 1H), 8.35 (s, 1H);  $^{13}\text{C}$  NMR ( $\text{CDCl}_3$ ):  $\delta$  20.3, 31.5, 34.5, 119.5, 124.5, 125.1, 125.86, 125.91, 126.2, 128.0, 128.1, 128.5, 128.9, 130.0, 130.2, 132.2, 132.3, 133.8, 136.7, 136.9, 150.6; EIMS  $m/z$  (relative intensity): 418 ( $M + 2$ , 100), 416 ( $M^+$ , 99.7); HRMS calcd for  $\text{C}_{26}\text{H}_{25}\text{Br}$ , 416.1139; found  $m/z$ , 416.1147.

To a cooled and stirred solution of 2-bromo-10-(4-tert-butyl-2,6-dimethylphenyl)anthracene (2.5 g, 5.9 mmol) in carbon tetrachloride (25 mL), a carbon tetrachloride solution (15 mL) of bromine (0.45 mL, 8.9 mmol) was added dropwise at 0 °C, and the mixture was stirred at room temperature overnight. To this mixture, an aqueous solution of 10% sodium hydroxide was added carefully. The reaction mixture was extracted with carbon tetrachloride, and the organic layer was washed with water and dried over anhydrous sodium sulfate. After removal of the solvent, **2,9-dibromo-10-(4-tert-butyl-2,6-dimethylphenyl)anthracene** was obtained as a yellow solid in 99% yield (3.0 g); mp 230.2–232.9 °C.  $^1\text{H}$  NMR ( $\text{CDCl}_3$ ):  $\delta$  1.43 (s, 9H), 1.71 (s, 6H), 7.24 (s, 2H), 7.33–7.45 (m, 3H), 7.48 (d,  $J$  = 0.6, 1H), 7.61 (ddd,  $J$  = 1.3, 6.4, 6.5 Hz, 1H), 8.57 (d,  $J$  = 9.0 Hz, 1H), 8.60 (dd,  $J$  = 8.8, 0.8 Hz, 1H);  $^{13}\text{C}$  NMR ( $\text{CDCl}_3$ ):  $\delta$  20.3, 31.5, 34.5, 120.8, 122.0, 124.6, 126.2, 126.6, 127.7, 128.1, 128.4, 128.8, 129.4, 130.0, 130.7, 131.0, 131.3, 133.4, 136.8, 137.4, 150.0; EIMS  $m/z$  (relative intensity): 498 ( $M + 4$ , 51.2), 496 ( $M + 2$ , 100), 494 ( $M^+$ , 51.6); HRMS calcd for  $\text{C}_{26}\text{H}_{24}\text{Br}_2$ , 494.0244; found  $m/z$ , 494.0243.

To a solution of the bromide (400 mg, 0.81 mmol) in anhydrous diethyl ether (10 mL) was added 2.4 M *n*-butyllithium in *n*-hexane (0.36 mL, 0.89 mmol) at 0 °C under nitrogen atmosphere, and the mixture was stirred for 2 h at 0 °C. A solution of absolute methyl formate (29  $\mu\text{L}$ , 0.49 mmol) in absolute diethyl ether (1 mL) was added to the lithiated mixture at 0 °C, and the mixture was refluxed overnight. The mixture was allowed to cool to room temperature, and a saturated ammonium chloride aqueous solution was added carefully. The reaction mixture was extracted with diethyl ether, and the organic layer was washed with water and dried over anhydrous sodium sulfate. After evaporation of the solvent, the residue was purified by GPC (six cycles, chloroform as eluent) to give **bis[2-bromo-10-(4-tert-butyl-2,6-dimethylphenyl)-9-anthryl]methanol** (163 mg, 47%) as a yellow solid; mp 174.5–176.9 °C.  $^1\text{H}$  NMR ( $\text{CDCl}_3$ ):  $\delta$  1.44 (s, 18H), 1.74 (s, 6H), 1.76 (s, 6H), 3.02 (d,  $J$  = 2.9 Hz, 1H), 7.23 (s, 2H), 7.26–7.54 (m,



8H), 8.52 (d,  $J = 9.0$  Hz, 4H), 8.86 (bs, 2H);  $^{13}\text{C}$  NMR ( $\text{CDCl}_3$ ):  $\delta$  20.3, 20.4, 31.5, 34.5, 73.0, 120.8, 124.6, 124.9, 125.4, 126.8, 127.3, 127.6, 128.2, 128.4, 128.8, 129.9, 130.4, 130.5, 132.2, 134.2, 136.8, 136.9, 138.9, 150.7; MS (MALDI-TOF) calcd for  $\text{C}_{53}\text{H}_{49}\text{Br}_2\text{O}$  ( $\text{M}^+$ ), 861.2169; found  $m/z$ , 861.2131.

Into a solution of the methanol (2.9 g, 3.3 mmol) in anhydrous benzene (70 mL) cooled to 0 °C, a hydrogen chloride gas generated by adding hydrochloric acid (4 mL) to sulfuric acid (6 mL) was bubbled for 1 h, and the mixture was stirred for 1 h at 0 °C. Removal of the solvent afforded bis[2-bromo-10-(4-*tert*-butyl-2,6-dimethylphenyl)-9-anthryl]chloromethane (2.9 g, quantitatively) as a brown solid. This was used without further purification since the chloride was found to be rather unstable. A solution of the chloromethane (2.9 g, 3.3 mmol) in anhydrous 1,4-dioxane (140 mL) was added to a molten mixture of silver tetrafluoroborate (973 mg, 5.0 mmol) and urethane (5.9 g, 66 mmol) at 60 °C. After addition was completed, the mixture was refluxed overnight. After being cooled, silver chloride was removed from the reaction mixture by filtration and was washed with chloroform. The filtrate was washed with water, and the organic layer was dried over anhydrous sodium sulfate and evaporated. The crude product was chromatographed on a silica gel column eluted with *n*-hexane/dichloromethane (1:1), and the main fraction was further chromatographed on a silica gel column eluted with ether. **Ethyl bis[2-bromo-10-(4-*tert*-butyl-2,6-dimethylphenyl)-9-anthryl]methylcarbamate** was obtained as a yellow solid in 21% yield (660 mg); mp 185.6–186.1 °C.  $^1\text{H}$  NMR ( $\text{CDCl}_3$ ):  $\delta$  1.31 (t,  $J = 7.0$  Hz, 3H), 1.43 (s, 18H), 1.70 (s, 6H), 1.73 (s, 6H), 4.27 (q,  $J = 8.1$  Hz, 2H), 5.94 (d,  $J = 7.4$  Hz, 1H), 7.19 (s, 4H), 7.29–7.36 (m, 6H), 7.52 (d,  $J = 8.5$  Hz, 2H), 8.58 (d,  $J = 7.4$  Hz, 1H), 8.70 (bs, 2H);  $^{13}\text{C}$  NMR ( $\text{CDCl}_3$ ):  $\delta$  14.7, 20.30, 20.34, 31.5, 34.5, 54.6, 61.6, 120.9, 124.0, 124.4, 124.5, 125.3, 126.7, 127.2, 127.5, 128.1, 128.2, 129.0, 130.1, 130.5, 130.6, 132.0, 136.8, 136.9, 138.7, 150.7, 155.4; MS (MALDI-TOF) calcd for  $\text{C}_{56}\text{H}_{53}\text{Br}_2\text{NO}_2$  ( $\text{M}^+$ ), 933.4075; found  $m/e$ , 933.2582.

To a solution of ethyl bis[2-bromo-10-(4-*tert*-butyl-2,6-dimethylphenyl)-9-anthryl] methylcarbamate (100 mg, 0.11 mmol) in anhydrous dioxane (2 mL), 2-(4-pyridyl)-4,4,5,5-tetramethyl-1,3-dioxaborolane (86 mg, 0.42 mmol), [1,1'-bis(diphenylphosphino)ferrocene]palladium dichloride dichloromethane complex:  $\text{PdCl}_2(\text{dppf})_2\cdot\text{CH}_2\text{Cl}_2$  (13 mg, 0.016 mol), and potassium phosphate (39 mg, 0.18 mmol) were added under Ar atmosphere, and the mixture was refluxed for 2 days. The mixture was then filtered, and filtrate was evaporated under reduced pressure. The resulting brown solid was purified by TLC ( $\text{Et}_2\text{O}$  only) to give **ethyl bis[10-(4-*tert*-butyl-2,6-dimethylphenyl)-2-(4-pyridyl)-9-anthryl]methylcarbamate** (24 mg, 25%) as a yellow solid.  $^1\text{H}$  NMR ( $\text{CDCl}_3$ ):  $\delta$  1.25–1.28 (m, 3H), 1.43 (s, 18H), 1.80 (s, 12H), 4.30 (bs, 2H), 6.41 (d,  $J = 7.2$  Hz, 1H), 6.58 (d,  $J = 9.2$  Hz, 4H), 7.19 (s, 4H), 7.37–7.68 (m, 10H), 8.23 (bs, 4H), 8.76 (d,  $J = 8.1$  Hz, 4H), 8.88 (d,  $J = 6.8$  Hz, 1H), 9.00 (s, 2H), 9.57 (d,  $J = 9.9$  Hz, 4H);  $^{13}\text{C}$  NMR ( $\text{CDCl}_3$ ):  $\delta$  14.7, 20.0, 20.4, 31.5, 34.5, 55.0, 61.6, 120.7, 123.5, 124.0, 124.5, 124.6, 125.3, 126.0, 127.5, 127.8, 128.4, 128.6, 129.6, 130.3, 130.7, 130.9, 133.9, 136.7, 136.9, 138.7, 147.2, 149.8, 150.7, 155.5; MS (MALDI-TOF) calcd for  $\text{C}_{56}\text{H}_{53}\text{Br}_2\text{NO}_2$  ( $\text{M}^+$ ), 930.6066; found  $m/z$ , 930.4993.

A dinitrogen tetraoxide (30 mg, 0.32 mmol) was bubbled into anhydrous carbon tetrachloride (5 mL) at  $-20$  °C. To this solution, sodium acetate (53 mg, 0.65 mmol) and a solution of the carbamate (30 mg, 0.032 mmol) in anhydrous carbon tetrachloride (0.5 mL) were added at  $-20$  °C, and the mixture was stirred for 2 h at 0 °C. The reaction mixture was poured into crushed ice and extracted with carbon tetrachloride. The organic layer was washed with aqueous sodium hydrogen carbonate and water and dried over anhydrous sodium sulfate. After evaporation of the solvent, a residual solid was dissolved in anhydrous tetrahydrofuran (5 mL) under nitrogen atmosphere and cooled to  $-20$  °C. Potassium *t*-butoxide (145 mg, 0.13 mmol) was added to the mixture, and the mixture was stirred overnight at room temperature. The reaction mixture was extracted with diethyl ether,

and the organic layer was washed with water and dried over anhydrous sodium sulfate. After evaporation of the solvent, the residue was purified by GPC (20 cycles, chloroform as eluent) to give diazomethane **2,2'-Dpy-1-N<sub>2</sub>** (8.9 mg, 32%) as a red solid.  $^1\text{H}$  NMR ( $\text{CDCl}_3$ ):  $\delta$  1.45 (s, 18H), 1.54 (s, 6H), 1.85 (s, 6H), 6.72 (bs, 4H), 7.23 (s, 2H), 7.29 (s, 2H), 7.47 (d,  $J = 7.7$  Hz, 2H), 7.34–7.49 (m, 8H), 8.27 (bs, 4H), 8.57 (s, 2H), 8.73 (d,  $J = 8.6$  Hz, 2H);  $^{13}\text{C}$  NMR ( $\text{CDCl}_3$ ):  $\delta$  20.0, 20.5, 31.5, 34.5, 55.5, 120.8, 123.5, 124.7, 124.9, 125.0, 126.2, 126.4, 128.0, 128.1, 128.3, 130.0, 130.1, 131.1, 131.7, 133.8, 134.7, 136.7, 136.8, 138.5, 147.1, 149.9, 150.9; IR (NaCl,  $\text{cm}^{-1}$ ): 3065vw, 2963s, 2919m, 2865m, 2220vw, 2040vs( $\nu_{\text{C}=\text{N}_2}$ ), 1595s, 1450w, 1406w, 1362m, 1302vw, 1227vw, 1194vw, 1098vw, 1071vw, 1040vw, 994m, 944vw, 907w, 870m, 837vw, 812w, 762m, 683vw.

**EPR Measurements.** The diazo compound was dissolved in 2-methyltetrahydrofuran ( $10^{-3}$  M), and the solution was degassed in a quartz cell by three freeze–degas–thaw cycles. The sample was cooled in an optical transmission EPR cavity at 77 K and irradiated with a Wacom 500 W Xe lamp using a Pyrex filter. EPR spectra were measured on a JEOL JES TE 200 spectrometer (X-band microwave unit, 100 kHz field modulation). The signal positions were read by the use of a gaussmeter. The temperature was controlled by a 9650 Microprocessor-based digital temperature indicator/controller and provided the measurement accuracy within  $\pm 0.1$  K and the control ability within  $\pm 0.2$  K. Errors in the measurements of component amplitudes did not exceed 5%, and the accuracy of the resonance fields determination was within  $\pm 0.5$  mT.

**Low-Temperature UV–Vis Spectra.** Low-temperature spectra at 77 K were obtained by using an Oxford variable-temperature liquid-nitrogen cryostat (DN 1704) equipped with a quartz outer window and a sapphire inner window. The sample was dissolved in dry 2-MTHF, placed in a long-necked quartz cuvette of 1-mm path length, and degassed thoroughly by repeated freeze–degas–thaw cycles at a pressure near  $10^{-5}$  Torr. The cuvette was flame-sealed under reduced pressure, placed in the cryostat, and cooled to 77 K. The sample was irradiated for several minutes in the spectrometer with a Halos 300-W high-pressure mercury lamp using a Pyrex filter, and the spectral changes were recorded at appropriate time intervals. The spectral changes upon thawing were also monitored by carefully controlling the matrix temperature with an Oxford Instrument intelligent temperature controller (ITC 4).

**Flash Photolysis.** All flash measurements were made on a Unisoku TSP-601 flash spectrometer. Three excitation light sources were used depending on the precursor absorption bands and lifetime of the transient species. They were (i) a cylindrical 150-W Xe flash lamp (100 J/flash with 10-ms pulse duration), (ii) a Quanta-Ray GCR-11 Nd:YAG laser (355-nm pulses of up to 40 mJ/pulse and 5–6-ns duration; 266-nm pulses of up to 30 mJ/pulse and 4–5-ns duration), and (iii) Lamda Physik LEXTRA XeCl excimer laser (308-nm pulses of up to 200 mJ/pulse and 17-ns duration). The beam shape and size were controlled by a focal length cylindrical lens.

A Hamamatsu 150 W xenon short arc lamp (L 2195) was used as the probe source, and the monitoring beam, guided using an optical fiber scope, was arranged in an orientation perpendicular to the excitation source. The probe beam was monitored with a Hamamatsu R2949 photomultiplier tube through a Hamamatsu S3701-512Q MOS linear image sensor (512 photodiodes used). Timing of the excitation pulse, the probe beam, and the detection system was achieved through an Iwatsu model DS-8631 digital synchro scope that was interfaced to an NEC 9801 RX2 computer. This allowed for rapid processing and storage of the data and provided printed graphic capabilities. Each trace was also displayed on a NEC CRT N5913U monitor.

A sample was placed in a long-necked Pyrex tube that had a sidearm connected to a quartz fluorescence cuvette and degassed using a minimum of four freeze–degas–thaw cycles at a pressure near  $10^{-5}$  Torr immediately before being flashed. The sample system was flame-sealed under reduced pressure, and the solution was transferred to the

quartz cuvette that was placed in the sample chamber of the flash spectrometer. A cell holder block of the sample chamber was equipped with a thermostat and allowed to come to thermal equilibrium. The concentration of the sample was adjusted so that it absorbed a significant portion of the excitation light. For experiments in which the rate constant for the reaction of oxygen with carbenes was determined, varying concentrations of oxygen in nitrogen were bubbled through the solution. MS analysis of the spent solution indicated the presence of the corresponding ketones; **2,2'-DPy-1-O**: MS(MALDI-TOF) calcd for  $C_{63}H_{57}N_2O$  ( $M^+ + H$ ), 857.45; found  $m/z$ , 857.57. **2,7-DPy-1-O**: MS-(MALDI-TOF) calcd for  $C_{63}H_{57}N_2O$  ( $M^+ + 2H$ ), 858.45; found  $m/z$ , 858.51.

**SQUID Measurements.** Magnetic susceptibility data were obtained on a Quantum Design MPMS-2A SQUID magnetometer/susceptometer. Irradiation with light from an argon ion laser (488 nm, Omnicrome 543-150BS) or He/Cd laser (442 nm, Melles Griot 2074-M A03) through a flexible optical fiber that passes through the inside of the SQUID sample holder was performed inside the sample room of SQUID apparatus at 5–11 K. One end of the optical fiber was located 40 mm above the sample cell (capsule), and the other was attached to a coupler for the laser. The bottom part of the capsule (6 mm  $\times$  10 mm) without a cap was used as a sample cell. A quantity of 50  $\mu$ L of the sample solution (1.0 mM) in 2-MTHF was placed in the cell that was held by a straw. The irradiation was carried out until there was no further change

of magnetization monitored at 5 K in a constant field of 5 kOe. The magnetization,  $M_b$  and  $M_a$ , before and after irradiation was measured at 2 K and 5 K in a field range 0–50 kOe. The plots of the magnetization [ $M = (M_a - M_b)$ ]:  $F$  stands for a photolysis factor of diazo compound] versus the magnetic field were analyzed in terms of Brillouin function.

**Acknowledgment.** We are grateful to the Ministry of Education, Culture, Sports, Science and Technology of Japan for support of this work through a Grant-in-Aid for Scientific Research for Specially Promoted Research (No. 12002007).

**Supporting Information Available:** ESR and UV–vis spectra obtained by irradiation of **2,2'-DPy-1-N<sub>2</sub>** in 2-methyltetrahydrofuran at 77 K, absorption of transient products formed during irradiation of diazo compound **2,2'-DPy-1-N<sub>2</sub>** in degassed and nondegassed benzene at room temperature, and UV–vis spectra obtained by irradiation of 1:1 mixture ( $1.5 \times 10^{-4}$  M) of **2,2'-DPy-1-N<sub>2</sub>** and  $Cu(hfac)_2$ , LFP of **DPy-1-N<sub>2</sub>** in 2-methyltetrahydrofuran at 77 K. See Figures S1–S6. This material is available free of charge via the Internet at <http://pubs.acs.org>.

JA0424225